



Luxurious Lifestyle

Price List 2019



Catalogue



ADVANCED MANUFACTURING FACILITIES

For more than ten years Sanjay Chilly has been in the forefront of floor drain manufacturing. This has been possible because of our advanced manufacturing facilities we set up in the very initial stage. We commissioned state of the art machines, presses, buffing, polishing and packaging units.

HIGHLIGHTS

1. Manufacturing facilities geared up to cater large volumes.
2. **ISO 9001: 2008 COMPANY**
3. In house design centre for churning out new product ideas

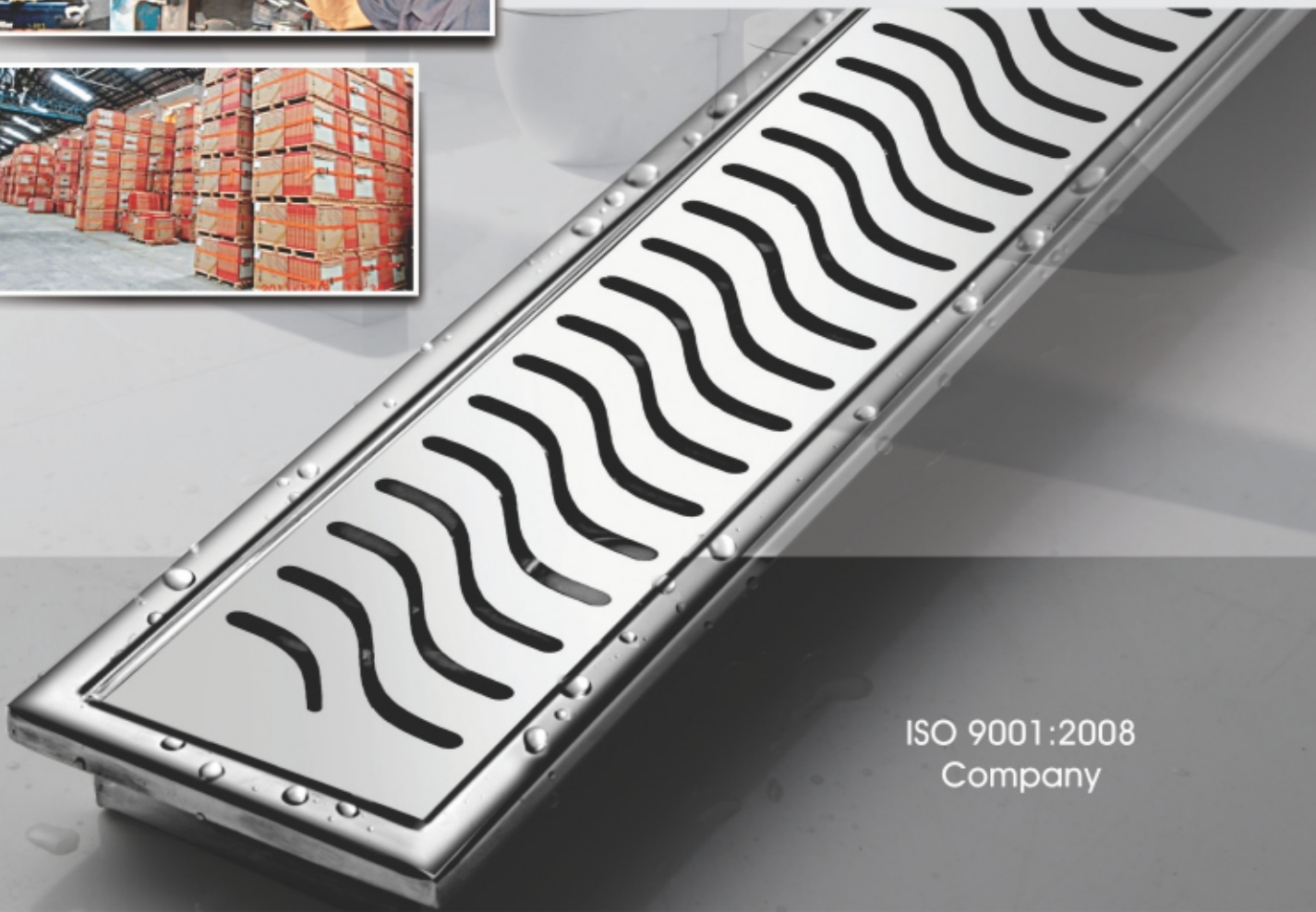

ISO 9001:2008
Company

with dedication, innovation
and commitment to quality
you can realise even the
most ambitious ideas

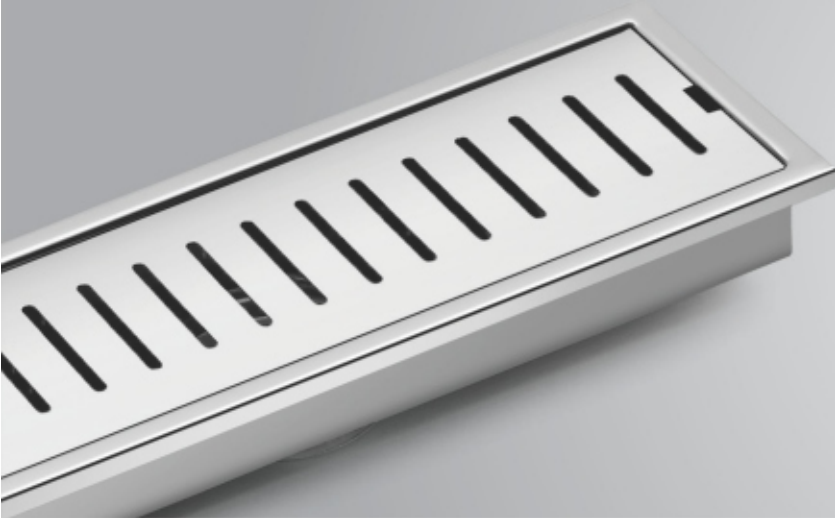

Sanjay Jain Chilly
Managing Director

Dear customers, there is nothing more important than the customer who ultimately will use the product which takes so long to create, manufacture, passed on to supply chain, delivered for distribution, changes hands at retail and finally reaches the customer.

At SANJAY CHILLY we live for the moment when the customer will buy the product and will smile at finding true value for the money they spent. For us, the urge for improvement and the rigorous development of innovation is a solidly established and resolutely pursued company principle. Since our foundation in 2007 we've invested tirelessly in new ideas, new technologies and surprising new solutions— always with our values and our customers' needs firmly in view. We can't help always being a little bit different.

Our core competence is producing high-quality drainage products and bathing accessories with design aspirations to match. We are continually strengthening our design, innovation and manufacturing capabilities and put together integrated bathroom solutions for our customers. These are a fusion of our decades of experience in the sanitary sector with outstanding support from our distribution, retail and customer base.

Read this brochure and find out more about SANJAY CHILLY's contribution as a supplier of exclusive bathroom and drainage solutions.



Keeping up with
highest industry
standards & letting
people enjoy the
technology

Sanjay Chilly manufactures products for the people. When we want to expand we think through the customer mind. It is not very hard to know what should be good product- whether it will serve its purpose in terms of functionality and performance. Our main focus is that the product should be elegant enough to pass the test of customer preferences.

In its quest for perfection
and
all inclusive excellence
Sanjay Chilly are now an
ISO 9001 2008
certified company



The water lock mechanism

The water lock created by the continuous presence of water in between the two filters keeps the cockroaches away since the cockroaches are unable to cross a water barrier



No Drain
Clogging



Eco Friendly



No odour
drain

SANJAY CHILLY

THE MAKING OF A PERFECT PRODUCT



RAW MATERIAL

Only The High Grade 304 Stainless Steel Is Procured, Tested And Then Allowed On The Shop Floor

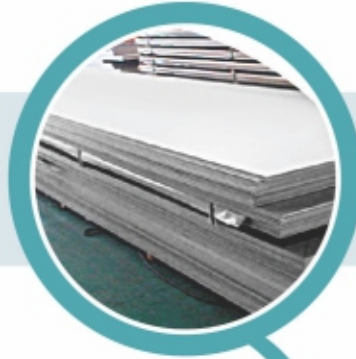

PROCESSING

Once inside the factory premises the steel is stacked and treated for final cutting



CUTTING

Cutting Of The Steel Is Done With Specially Commissioned Presses For The Final Production



PRESSING

At the state of the art presses the cut sheets are moulded to the various shapes



BEADING

The process of beading is crucial for the products because it imparts them with safe rounded corners



LANCER/GRINDING

Grinding is the process which takes away the blemishes on the product surface and makes it smooth and user friendly



BUFFING

Buffing Is Finishing Process For Smoothing A Workpiece's Surface Using An Abrasive And A Work Wheel Or A Leather Strop.



POLISHING

Polishing is finishing process for shining a workpiece's surface using an abrasive and a work wheel or a leather strop.



CHECKING & PACKING

Before the products are packed in protective polythene and later into boxes they are thoroughly checked and if found wanting are sent back to shop floor



SHIPPING

Sanjay Chilly is committed to meeting supply chain deadlines to make it possible we take extra care to dispatch deliveries faster and safe

Content

09-12	SCCT SQUARE	68-69	PISTO SUPER
13-15	SCCT ROUND	70	AMAZE SERIES ROUND
16-17	PLATINO ROUND & SQUARE	71	VERTICAL GRATING
18-19	SCCT LIFESTYLE SQUARE & ROUND	72	GOLDEN CLASSIC
<hr/>			
20-24	SCCT GOLDEN SERIES	73-76	THREE 'O' FOUR SQUARE
25-29	PURE GOLD & ROSE GOLD SERIES	77-80	THREE 'O' FOUR SQUARE GOLDEN SERIES
30-32	SCCT TILE DRAINER	81-83	THREE 'O' FOUR ROUND
33	ONEX SERIES	84	RAIL DRAINER SQUARE
<hr/>			
34	SCCT HEAVY TRAFFIC SQUARE & ROUND	85	RAIL DRAINER
35-36	SCCT LITE SQUARE	86	HEALTH FAUCET
37	SCCT LITE ROUND	87	JET SPRAY
38	POP UP DRAIN SQUARE & ROUND	88	WASTE COUPLING
<hr/>			
39-40	EXOTIC SERIES & FCT	89	BOTTLE TRAP
41-51	SHOWER CHANNEL DRAINER	90	WASTE PIPE
52	ROOF DRAIN SQUARE & ROUND	91	SOAP DISH
53	ROOF DRAIN CAST	92	LIQUID SOAP DISPENSER
<hr/>			
54-55	INDIA KING SQUARE & ROUND	93	TOILET PAPER HOLDER
56-57	CLEAN OUT SQUARE & ROUND	94	FLANGES
58-59	SANITROKING SQUARE DOOM TYPE	95	RACK BOLTS
60-62	SANITROKING SQUARE FLAT TYPE	96	CONNECTION HOSE
<hr/>			
63	SANITROKING ROUND DOOM TYPE	97	EXTENSION NIPPLE
64-65	SANITROKING SQUARE FLAT TYPE	98	ALLIED
66	SANISQUARE	99	BATH SPOUTS
67	AMAZE SERIES SQUARE	100	SHOWER ARM
<hr/>			

SCCT

SQUARE

HSN Code: 7326.90.30

AISI 304 (18/8) Stainless Steel

Price Per Pc. in INR



1	Code	Bright	Matt
	SCCT-SFC-76 Square Flat Cut	570/-	620/-
	SCCT-SFCH-76 Square Flat Cut Hinge	670/-	720/-
	SCCT-SFCS-76 Square Flat Cut Screw	670/-	720/-

2	Code	Bright	Matt
	SCCT-SGFC-76 Square Gypsy Flat Cut	570/-	620/-
	SCCT-SGFCH-76 Square Gypsy Flat Cut Hinge	670/-	720/-
	SCCT-SGFCS-76 Square Gypsy Flat Cut Screw	670/-	720/-

3	Code	Bright	Matt
	SCCT-SRFC-76 Square Ringo Flat Cut	620/-	670/-
	SCCT-SRFCH-76 Square Ringo Flat Cut Hinge	670/-	720/-
	SCCT-SRFCS-76 Square Ringo Flat Cut Screw	670/-	720/-

4	Code	Bright	Matt
	SCCT-SFC-101 Square Flat Cut	760/-	860/-
	SCCT-SFCH-101 Square Flat Cut Hinge	860/-	960/-
	SCCT-SFCS-101 Square Flat Cut Screw	860/-	960/-
	SCCT-SFCL-101 Square Flat Cut Lock	810/-	910/-

5	Code	Bright	Matt
	SCCT-SGFC-101 Square Gypsy Flat Cut	760/-	860/-
	SCCT-SGFCH-101 Square Gypsy Flat Cut Hinge	860/-	960/-
	SCCT-SGFCS-101 Square Gypsy Flat Cut Screw	860/-	960/-
	SCCT-SGFCL-101 Square Gypsy Flat Cut Lock	810/-	910/-

6	Code	Bright	Matt
	SCCT-SCFC-101 Square Classic Flat Cut	800/-	900/-
	SCCT-SCFCH-101 Square Classic Flat Cut Hinge	900/-	1000/-
	SCCT-SCFCS-101 Square Classic Flat Cut Screw	900/-	1000/-
	SCCT-SCFCL-101 Square Classic Flat Cut Lock	850/-	950/-

7	Code	Bright	Matt
	SCCT-SRFC-101 Square Ringo Flat Cut	800/-	900/-
	SCCT-SRFCH-101 Square Ringo Flat Cut Hinge	900/-	1000/-
	SCCT-SRFCS-101 Square Ringo Flat Cut Screw	900/-	1000/-
	SCCT-SRFCL-101 Square Ringo Flat Cut Lock	850/-	950/-

SCCT

SQUARE

HSN Code: 7326.90.30

AISI 304 (18/8) Stainless Steel

Price Per Pc. in INR

8	Code	Bright	Matt
	SCCT-SFC-127 Square Flat Cut	810/-	910/-
	SCCT-SFCH-127 Square Flat Cut Hinge	910/-	1010/-
	SCCT-SFCS-127 Square Flat Cut Screw	910/-	1010/-
	SCCT-SFCL-127 Square Flat Cut Lock	860/-	960/-

9	Code	Bright	Matt
	SCCT-SGFC-127 Square Gypsy Flat Cut	810/-	910/-
	SCCT-SGFCH-127 Square Gypsy Flat Cut Hinge	910/-	1010/-
	SCCT-SGFCS-127 Square Gypsy Flat Cut Screw	910/-	1010/-
	SCCT-SGFCL-127 Square Gypsy Flat Cut Lock	860/-	960/-

10	Code	Bright	Matt
	SCCT-SCFC-127 Square Classic Flat Cut	910/-	1010/-
	SCCT-SCFCH-127 Square Classic Flat Cut Hinge	1010/-	1110/-
	SCCT-SCFCS-127 Square Classic Flat Cut Screw	1010/-	1110/-
	SCCT-SCFCL-127 Square Classic Flat Cut Lock	960/-	1060/-

11	Code	Bright	Matt
	SCCT-SCGFC-127 Square Classic Gypsy Flat Cut	910/-	1010/-
	SCCT-SCGFCH-127 Square Classic Gypsy Flat Cut Hinge	1010/-	1110/-
	SCCT-SCGFCS-127 Square Classic Gypsy Flat Cut Screw	1010/-	1110/-
	SCCT-SCGFCL-127 Square Classic Gypsy Flat Cut Lock	960/-	1060/-

12	Code	Bright	Matt
	SCCT-SRFC-127 Square Ringo Flat Cut	910/-	1010/-
	SCCT-SRFCH-127 Square Ringo Flat Cut Hinge	1010/-	1110/-
	SCCT-SRFCS-127 Square Ringo Flat Cut Screw	1010/-	1110/-
	SCCT-SRFCL-127 Square Ringo Flat Cut Lock	960/-	1060/-

13	Code	Bright	Matt
	SCCT-SRGFC-127 Square Ringo Gypsy Flat Cut	910/-	1010/-
	SCCT-SRGFCH-127 Square Ringo Gypsy Flat Cut Hinge	1010/-	1110/-
	SCCT-SRGFCS-127 Square Ringo Gypsy Flat Cut Screw	1010/-	1110/-
	SCCT-SRGFCL-127 Square Ringo Gypsy Flat Cut Lock	960/-	1060/-

14	Code	Bright	Matt
	SCCT-SEFC-127 Square Ezee Flat Cut	910/-	1010/-
	SCCT-SEFCH-127 Square Ezee Flat Cut Hinge	1010/-	1110/-
	SCCT-SEFCS-127 Square Ezee Flat Cut Screw	1010/-	1110/-
	SCCT-SEFCL-127 Square Ezee Flat Cut Lock	960/-	1060/-

15	Code	Bright	Matt
	SCCT-SEGFC-127 Square Ezee Gypsy Flat Cut	910/-	1010/-
	SCCT-SEGFCH-127 Square Ezee Gypsy Flat Cut Hinge	1010/-	1110/-
	SCCT-SEGFCS-127 Square Ezee Gypsy Flat Cut Screw	1010/-	1110/-
	SCCT-SEGFCL-127 Square Ezee Gypsy Flat Cut Lock	960/-	1060/-

SCCT

SQUARE

HSN Code: 7326.90.30

AISI 304 (18/8) Stainless Steel

Price Per Pc. in INR

16	Code	Bright	Matt
	SCCT-SFC-153 Square Flat Cut	910/-	1010/-
	SCCT-SFCH-153 Square Flat Cut Hinge	1010/-	1110/-
	SCCT-SFCS-153 Square Flat Cut Screw	1010/-	1110/-
	SCCT-SFCL-153 Square Flat Cut Lock	960/-	1060/-

17	Code	Bright	Matt
	SCCT-SGFC-153 Square Gypsy Flat Cut	910/-	1010/-
	SCCT-SGFCH-153 Square Gypsy Flat Cut Hinge	1010/-	1110/-
	SCCT-SGFCS-153 Square Gypsy Flat Cut Screw	1010/-	1110/-
	SCCT-SGFCL-153 Square Gypsy Flat Cut Lock	960/-	1060/-

18	Code	Bright	Matt
	SCCT-SCFC-153 Square Classic Flat Cut	1010/-	1110/-
	SCCT-SCFCH-153 Square Classic Flat Cut Hinge	1110/-	1210/-
	SCCT-SCFCS-153 Square Classic Flat Cut Screw	1110/-	1210/-
	SCCT-SCFCL-153 Square Classic Flat Cut Lock	1060/-	1160/-

19	Code	Bright	Matt
	SCCT-SCGFC-153 Square Classic Gypsy Flat Cut	1010/-	1110/-
	SCCT-SCGFCH-153 Square Classic Gypsy Flat Cut Hinge	1110/-	1210/-
	SCCT-SCGFCS-153 Square Classic Gypsy Flat Cut Screw	1110/-	1210/-
	SCCT-SCGFCL-153 Square Classic Gypsy Flat Cut Lock	1060/-	1160/-

20	Code	Bright	Matt
	SCCT-SRFC-153 Square Ringo Flat Cut	1010/-	1110/-
	SCCT-SRFCH-153 Square Ringo Flat Cut Hinge	1110/-	1210/-
	SCCT-SRFCS-153 Square Ringo Flat Cut Screw	1110/-	1210/-
	SCCT-SRFCL-153 Square Ringo Flat Cut Lock	1060/-	1160/-

21	Code	Bright	Matt
	SCCT-SRGFC-153 Square Ringo Gypsy Flat Cut	1010/-	1110/-
	SCCT-SRGFCH-153 Square Ringo Gypsy Flat Cut Hinge	1110/-	1210/-
	SCCT-SRGFCS-153 Square Ringo Gypsy Flat Cut Screw	1110/-	1210/-
	SCCT-SRGFCL-153 Square Ringo Gypsy Flat Cut Lock	1060/-	1160/-

22	Code	Bright	Matt
	SCCT-SEFC-153 Square Ezee Flat Cut	1010/-	1110/-
	SCCT-SEFCH-153 Square Ezee Flat Cut Hinge	1110/-	1210/-
	SCCT-SEFCS-153 Square Ezee Flat Cut Screw	1110/-	1210/-
	SCCT-SEFCL-153 Square Ezee Flat Cut Lock	1060/-	1160/-

23	Code	Bright	Matt
	SCCT-SEGFC-153 Square Ezee Gypsy Flat Cut	1010/-	1110/-
	SCCT-SEGFCH-153 Square Ezee Gypsy Flat Cut Hinge	1110/-	1210/-
	SCCT-SEGFCS-153 Square Ezee Gypsy Flat Cut Screw	1110/-	1210/-
	SCCT-SEGFCL-153 Square Ezee Gypsy Flat Cut Lock	1060/-	1160/-

SCCT

SQUARE

HSN Code: 7326.90.30

AISI 304 (18/8) Stainless Steel

Price Per Pc. in INR

24	Code	Bright	Matt
	SCCT-SFC-200 Square Flat Cut	3400/-	3600/-
	SCCT-SFCH-200 Square Flat Cut Hinge	3500/-	3700/-
	SCCT-SFCS-200 Square Flat Cut Screw	3500/-	3700/-

25	Code	Bright	Matt
	SCCT-SGFC-200 Square Gypsy Flat Cut	3400/-	3600/-
	SCCT-SGFCH-200 Square Gypsy Flat Cut Hinge	3500/-	3700/-
	SCCT-SGFCS-200 Square Gypsy Flat Cut Screw	3500/-	3700/-

26	Code	Bright	Matt
	SCCT-SFC-255 Square Flat Cut	4700/-	4900/-
	SCCT-SFCH-255 Square Flat Cut Hinge	4800/-	5000/-
	SCCT-SFCS-255 Square Flat Cut Screw	4800/-	5000/-

27	Code	Bright	Matt
	SCCT-SGFC-255 Square Gypsy Flat Cut	4700/-	4900/-
	SCCT-SGFCH-255 Square Gypsy Flat Cut Hinge	4800/-	5000/-
	SCCT-SGFCS-255 Square Gypsy Flat Cut Screw	4800/-	5000/-

28	Code	Bright	Matt
	SCCT-SFC-300 Square Flat Cut	6300/-	6500/-
	SCCT-SFCH-300 Square Flat Cut Hinge	6400/-	6600/-
	SCCT-SFCS-300 Square Flat Cut Screw	6400/-	6600/-

29	Code	Bright	Matt
	SCCT-SGFC-300 Square Gypsy Flat Cut	6300/-	6500/-
	SCCT-SGFCH-300 Square Gypsy Flat Cut Hinge	6400/-	6600/-
	SCCT-SGFCS-300 Square Gypsy Flat Cut Screw	6400/-	6600/-

SCCT

ROUND

HSN Code: 7326.90.30

AISI 304 (18/8) Stainless Steel

Price Per Pc. in INR



1	Code	Bright	Matt
	SCCT-R-80 Round	520/-	570/-
	SCCT-RH-80 Round Hinge	620/-	670/-
	SCCT-RS-80 Round Screw	620/-	670/-

2	Code	Bright	Matt
	SCCT-RG-80 Round Gypsy	520/-	570/-
	SCCT-RGH-80 Round Gypsy Hinge	620/-	670/-
	SCCT-RGS-80 Round Gypsy Screw	620/-	670/-

3	Code	Bright	Matt
	SCCT-RR-80 Round Ringo	570/-	620/-
	SCCT-RRH-80 Round Ringo Hinge	620/-	670/-
	SCCT-RRS-80 Round Ringo Screw	620/-	670/-

4	Code	Bright	Matt
	SCCT-R-101 Round	660/-	760/-
	SCCT-RH-101 Round Hinge	760/-	860/-
	SCCT-RS-101 Round Screw	760/-	860/-
	SCCT-RL-101 Round Lock	710/-	810/-

5	Code	Bright	Matt
	SCCT-RG-101 Round Gypsy	660/-	760/-
	SCCT-RGH-101 Round Gypsy Hinge	760/-	860/-
	SCCT-RGS-101 Round Gypsy Screw	760/-	860/-
	SCCT-RGL-101 Round Gypsy Lock	710/-	810/-

6	Code	Bright	Matt
	SCCT-RC-101 Round Classic	700/-	800/-
	SCCT-RCH-101 Round Classic Hinge	800/-	900/-
	SCCT-RCS-101 Round Classic Screw	800/-	900/-
	SCCT-RCL-101 Round Classic Lock	750/-	850/-

7	Code	Bright	Matt
	SCCT-RR-101 Round Ringo	700/-	800/-
	SCCT-RRH-101 Round Ringo Hinge	800/-	900/-
	SCCT-RRS-101 Round Ringo Screw	800/-	900/-
	SCCT-RRL-101 Round Ringo Lock	750/-	850/-

SCCT

ROUND

HSN Code: 7326.90.30

AISI 304 (18/8) Stainless Steel

Price Per Pc. in INR

8	Code	Bright	Matt
	SCCT-R-127 Round	710/-	810/-
	SCCT-RH-127 Round Hinge	810/-	910/-
	SCCT-RS-127 Round Screw	810/-	910/-
	SCCT-RL-127 Round Lock	760/-	860/-

9	Code	Bright	Matt
	SCCT-RG-127 Round Gypsy	710/-	810/-
	SCCT-RGH-127 Round Gypsy Hinge	810/-	910/-
	SCCT-RGS-127 Round Gypsy Screw	810/-	910/-
	SCCT-RGL-127 Round Gypsy Lock	760/-	860/-

10	Code	Bright	Matt
	SCCT-RC-127 Round Classic	810/-	910/-
	SCCT-RCH-127 Round Classic Hinge	910/-	1010/-
	SCCT-RCS-127 Round Classic Screw	910/-	1010/-
	SCCT-RCL-127 Round Classic Lock	860/-	960/-

11	Code	Bright	Matt
	SCCT-RCG-127 Round Classic Gypsy	810/-	910/-
	SCCT-RCGH-127 Round Classic Gypsy Hinge	910/-	1010/-
	SCCT-RCGS-127 Round Classic Gypsy Screw	910/-	1010/-
	SCCT-RCGL-127 Round Classic Gypsy Lock	860/-	960/-

12	Code	Bright	Matt
	SCCT-RR-127 Round Ringo	810/-	910/-
	SCCT-RRH-127 Round Ringo Hinge	910/-	1010/-
	SCCT-RRS-127 Round Ringo Screw	910/-	1010/-
	SCCT-RRL-127 Round Ringo Lock	860/-	960/-

13	Code	Bright	Matt
	SCCT-RRG-127 Round Ringo Gypsy	810/-	910/-
	SCCT-RRGH-127 Round Ringo Gypsy Hinge	910/-	1010/-
	SCCT-RRGS-127 Round Ringo Gypsy Screw	910/-	1010/-
	SCCT-RRGL-127 Round Ringo Gypsy Lock	860/-	960/-

14	Code	Bright	Matt
	SCCT-RE-127 Round Ezee	810/-	910/-
	SCCT-REH-127 Round Ezee Hinge	910/-	1010/-
	SCCT-RES-127 Round Ezee Screw	910/-	1010/-
	SCCT-REL-127 Round Ezee Lock	860/-	960/-

15	Code	Bright	Matt
	SCCT-REG-127 Round Ezee Gypsy	810/-	910/-
	SCCT-REGH-127 Round Ezee Gypsy Hinge	910/-	1010/-
	SCCT-REGS-127 Round Ezee Gypsy Screw	910/-	1010/-
	SCCT-REGL-127 Round Ezee Gypsy Lock	860/-	960/-

SCCT

ROUND

HSN Code: 7326.90.30

AISI 304 (18/8) Stainless Steel

Price Per Pc. in INR

16	Code	Bright	
	SCCT-RFC-205 Round Flat Cut	3000/-	3100/-
	SCCT-RFCH-205 Round Flat Cut Hinge	3100/-	3200/-
	SCCT-RFCS-205 Round Flat Cut Screw	3100/-	3200/-

17	Code	Bright	Matt
	SCCT-RGFC-205 Round Gypsy Flat Cut	3000/-	3100/-
	SCCT-RGFCH-205 Round Gypsy Flat Cut Hinge	3100/-	3200/-
	SCCT-RGFCS-205 Round Gypsy Flat Cut Screw	3100/-	3200/-



PLATINO SERIES

ROUND & SQUARE

HSN Code: 7418.20.10

100% BRASS CHROME PLATED

Price Per Pc. in INR

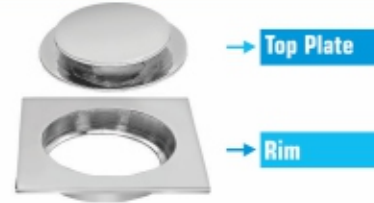

IN 5MM THICKNESS

SUPER PREMIUM

1	Code	Chrome
	SCCT-RP-80 Round Plantino	1240/-

2	Code	Chrome
	RP-80 Round Plantino	1040/-

3	Code	Chrome
	SCCT-RP-100 Round Plantino	1610/-

4	Code	Chrome
	RP-100 Round Plantino	1360/-

5	Code	Chrome
	SCCT-RP-125 Round Plantino	2050/-

6	Code	Chrome
	RP-125 Round Plantino	1760/-

PLATINO SERIES

ROUND & SQUARE

HSN Code: 7418.20.10

100% BRASS CHROME PLATED

Price Per Pc. in INR

7	Code	Chrome
	SCCT-SP-80 Square Plantino	1390/-

8	Code	Chrome
	SP-80 Square Plantino	1190/-

9	Code	Chrome
	SCCT-SP-100 Square Plantino	1810/-

10	Code	Chrome
	SP-100 Square Plantino	1560/-

11	Code	Chrome
	SCCT-SP-125 Square Plantino	2250/-

12	Code	Chrome
	SP-125 Square Plantino	1960/-

13	Code	Chrome
	SCCT-SP-150 Square Plantino	2910/-

14	Code	Chrome
	SP-150 Square Plantino	2620/-

SCCT LIFESTYLE



SQUARE & ROUND

HSN Code: 7326.90.30

AISI 304 (18/8) Stainless Steel

Price Per Pc. in INR

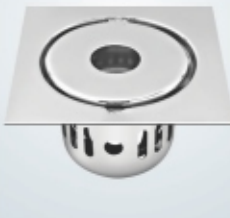

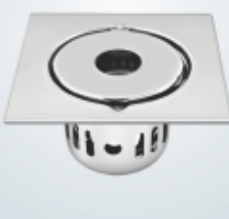
1	Code	Bright	Matt	2	Code	Bright	Matt
	SCCT-LS-140 Lifestyle Square With Hidden Hinge	1550/-	1650/-		SCCT-LSG-140 Lifestyle Square Gypsy With Hidden Hinge	1550/-	1650/-
	SCCT-LS-Pop Up-140 Lifestyle Square Pop Up	1550/-	1650/-		SCCT-LS-150 Lifestyle Square With Hidden Hinge	1650/-	1750/-
	SCCT-LSG-150 Lifestyle Square Gypsy With Hidden Hinge	1650/-	1750/-		SCCT-LS-Pop Up-150 Lifestyle Square Pop Up	1650/-	1750/-

SCCT LIFESTYLE

SQUARE & ROUND

HSN Code: 7326.90.30

AISI 304 (18/8) Stainless Steel

Price Per Pc. in INR

7	Code	Bright	Matt
	SCCT-L-R-138 Lifestyle Round With Hidden Hinge	1350/-	1450/-

8	Code	Bright	Matt
	SCCT-L-RG-138 Lifestyle Round Gypsy With Hidden Hinge	1350/-	1450/-

9	Code	Bright	Matt
	SCCT-L-R-Pop Up-138 Lifestyle Round Pop Up	1350/-	1450/-

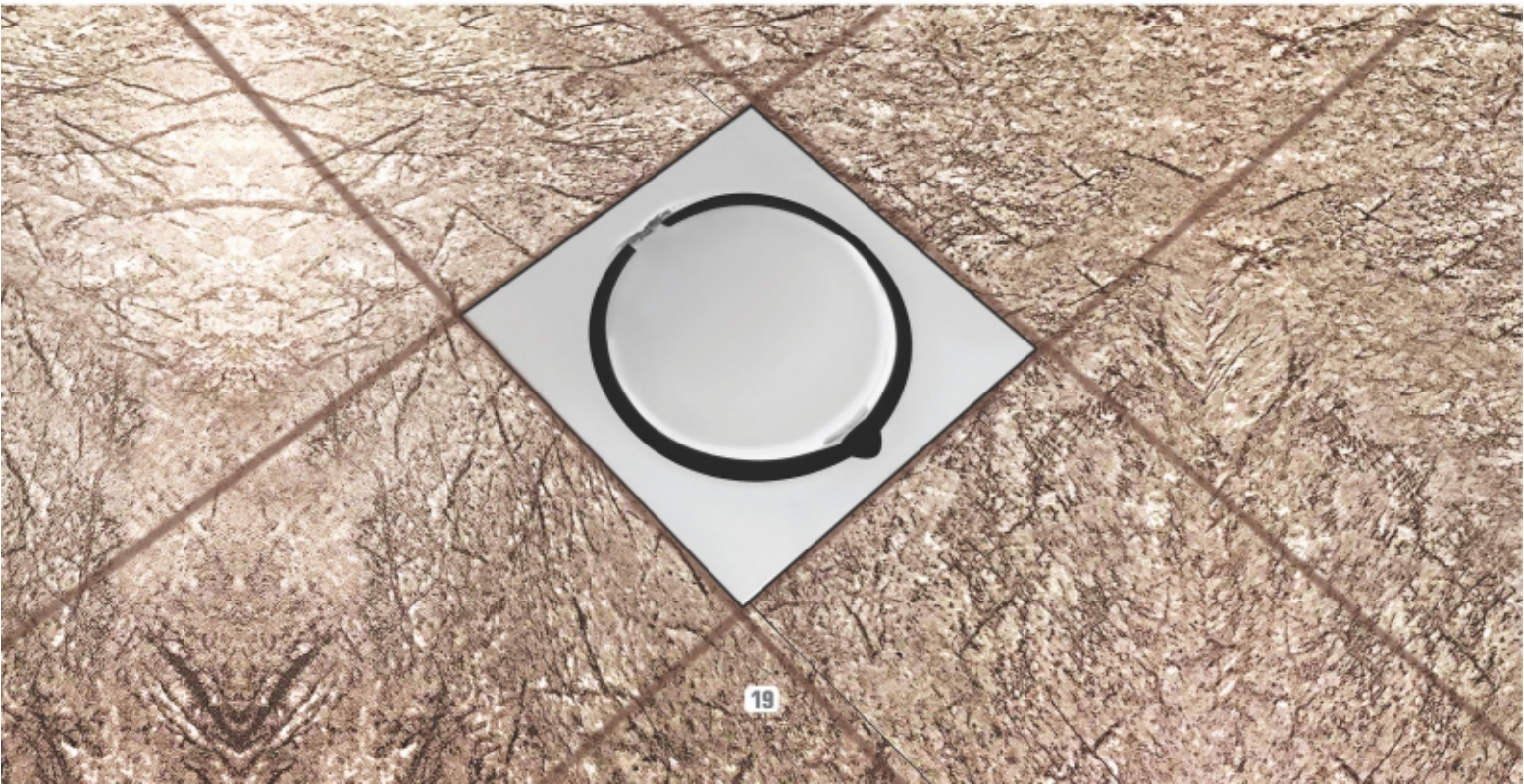

SCCT GOLDEN SERIES

SQUARE

HSN Code: 7326.90.30

AISI 304 (18/8) Stainless Steel

Price Per Pc. in INR



1	Code	Bright	Matt
	SCCT-SFC-GS-127 Square Flat Cut Golden Series	950/-	1050/-
	SCCT-SFCH-GS-127 Square Flat Cut Golden Series Hinge	1050/-	1150/-
	SCCT-SFCS-GS-127 Square Flat Cut Golden Series Screw	1050/-	1150/-

2	Code	Bright	Matt
	SCCT-SGFC-GS-127 Square Gypsy Flat Cut Golden Series	950/-	1050/-
	SCCT-SGFCH-GS-127 Square Gypsy Flat Cut Golden Series Hinge	1050/-	1150/-
	SCCT-SGFCS-GS-127 Square Flat Cut Golden Series Screw	1050/-	1150/-

3	Code	Bright	Matt
	SCCT-SCFC-GS-127 Square Classic Flat Cut Golden Series	950/-	1050/-
	SCCT-SCFCH-GS-127 Square Classic Flat Cut Golden Series Hinge	1050/-	1150/-
	SCCT-SCFCS-GS-127 Square Classic Flat Cut Golden Series Screw	1050/-	1150/-

4	Code	Bright	Matt
	SCCT-SCGFC-GS-127 Square Classic Gypsy Flat Cut Golden Series	950/-	1050/-
	SCCT-SCGFCH-GS-127 Square Classic Gypsy Flat Cut Golden Series Hinge	1050/-	1150/-
	SCCT-SCGFCS-GS-127 Square Classic Gypsy Flat Cut Golden Series Screw	1050/-	1150/-

5	Code	Bright	Matt
	SCCT-SEFC-GS-127 Square Ezee Flat Cut Golden Series	950/-	1050/-
	SCCT-SEFCH-GS-127 Square Ezee Flat Cut Golden Series Hinge	1050/-	1150/-
	SCCT-SEFCS-GS-127 Square Ezee Flat Cut Golden Series Screw	1050/-	1150/-

6	Code	Bright	Matt
	SCCT-SEGFC-GS-127 Square Ezee Gypsy Flat Cut Golden Series	950/-	1050/-
	SCCT-SEGFCH-GS-127 Square Ezee Gypsy Flat Cut Golden Series Hinge	1050/-	1150/-
	SCCT-SEGFCS-GS-127 Square Ezee Gypsy Flat Cut Golden Series Screw	1050/-	1150/-

SCCT GOLDEN SERIES

SQUARE

HSN Code: 7326.90.30

AISI 304 (18/8) Stainless Steel

Price Per Pc. in INR

7	Code	Bright	Matt
	SCCT-SVFC-GS-127 Square Vertical Flat Cut Golden Series	950/-	1050/-
	SCCT-SVFCH-GS-127 Square Vertical Flat Cut Golden Series Hinge	1050/-	1150/-
	SCCT-SVFCS-GS-127 Square Vertical Flat Cut Golden Series Screw	1050/-	1150/-

8	Code	Bright	Matt
	SCCT-SVGFC-GS-127 Square Vertical Gypsy Flat Cut Golden Series	950/-	1050/-
	SCCT-SVGFCH-GS-127 Square Vertical Gypsy Flat Cut Golden Series Hinge	1050/-	1150/-
	SCCT-SVGFCS-GS-127 Square Vertical Gypsy Flat Cut Golden Series Screw	1050/-	1150/-

9	Code	Bright	Matt
	SCCT-SZFC-GS-127 Square Zoom Flat Cut Golden Series	950/-	1050/-
	SCCT-SZFCH-GS-127 Square Zoom Flat Cut Golden Series Hinge	1050/-	1150/-
	SCCT-SZFCS-GS-127 Square Zoom Flat Cut Golden Series Screw	1050/-	1150/-

10	Code	Bright	Matt
	SCCT-SZGFC-GS-127 Square Zoom Gypsy Flat Cut Golden Series	950/-	1050/-
	SCCT-SZGFCH-GS-127 Square Zoom Gypsy Flat Cut Golden Series Hinge	1050/-	1150/-
	SCCT-SZGFCS-GS-127 Square Zoom Gypsy Flat Cut Golden Series Screw	1050/-	1150/-

11	Code	Bright	Matt
	SCCT-SMFC-GS-127 Square Maze Flat Cut Golden Series	950/-	1050/-
	SCCT-SMFCH-GS-127 Square Maze Flat Cut Golden Series Hinge	1050/-	1150/-
	SCCT-SMFCS-GS-127 Square Maze Flat Cut Golden Series Screw	1050/-	1150/-

12	Code	Bright	Matt
	SCCT-SMGFC-GS-127 Square Maze Gypsy Flat Cut Golden Series	950/-	1050/-
	SCCT-SMGFCH-GS-127 Square Maze Gypsy Flat Cut Golden Series Hinge	1050/-	1150/-
	SCCT-SMGFCS-GS-127 Square Maze Gypsy Flat Cut Golden Series Screw	1050/-	1150/-

13	Code	Bright	Matt
	SCCT-SRFC-GS-127 Square Ringo Flat Cut Golden Series	950/-	1050/-
	SCCT-SRFCH-GS-127 Square Ringo Flat Cut Golden Series Hinge	1050/-	1150/-
	SCCT-SRFCS-GS-127 Square Ringo Flat Cut Golden Series Screw	1050/-	1150/-

14	Code	Bright	Matt
	SCCT-SRGFC-GS-127 Square Ringo Gypsy Flat Cut Golden Series	950/-	1050/-
	SCCT-SRGFCH-GS-127 Square Ringo Gypsy Flat Cut Golden Series Hinge	1050/-	1150/-
	SCCT-SRGFCS-GS-127 Square Ringo Gypsy Flat Cut Golden Series Screw	1050/-	1150/-

SCCT GOLDEN SERIES

SQUARE

HSN Code: 7326.90.30

AISI 304 (18/8) Stainless Steel

Price Per Pc. in INR

15	Code	Bright	Matt
	SCCT-SCLFC-GS-127 Square Clean Line Flat Cut Golden Series	950/-	1050/-
	SCCT-SCLFCH-GS-127 Square Clean Line Flat Cut Hinge Golden Series	1050/-	1150/-
	SCCT-SCLFCS-GS-127 Square Clean Line Flat Cut Screw Golden Series	1050/-	1150/-

16	Code	Bright	Matt
	SCCT-SCLGFC-GS-127 Square Clean Line Gypsy Flat Cut Golden Series	950/-	1050/-
	SCCT-SCLGFCH-GS-127 Square Clean Line Gypsy Flat Cut Hinge Golden Series	1050/-	1150/-
	SCCT-SCLGFCS-GS-127 Square Clean Line Gypsy Flat Cut Screw Golden Series	1050/-	1150/-

17	Code	Bright	Matt
	SCCT-SFC-GS-153 Square Flat Cut Golden Series	1050/-	1150/-
	SCCT-SFCH-GS-153 Square Flat Cut Golden Series Hinge	1150/-	1250/-
	SCCT-SFCS-GS-153 Square Flat Cut Golden Series Screw	1150/-	1250/-

18	Code	Bright	Matt
	SCCT-SGFC-GS-153 Square Gypsy Flat Cut Golden Series	1050/-	1150/-
	SCCT-SGFCH-GS-153 Square Gypsy Flat Cut Golden Series Hinge	1150/-	1250/-
	SCCT-SGFCS-GS-153 Square Gypsy Flat Cut Golden Series Screw	1150/-	1250/-

19	Code	Bright	Matt
	SCCT-SCFC-GS-153 Square Classic Flat Cut Golden Series	1050/-	1150/-
	SCCT-SCFCH-GS-153 Square Classic Flat Cut Golden Series Hinge	1150/-	1250/-
	SCCT-SCFCS-GS-153 Square Classic Flat Cut Golden Series Screw	1150/-	1250/-

20	Code	Bright	Matt
	SCCT-SCGFC-GS-153 Square Classic Gypsy Flat Cut Golden Series	1050/-	1150/-
	SCCT-SCGFCH-GS-153 Square Classic Gypsy Flat Cut Golden Series Hinge	1150/-	1250/-
	SCCT-SCGFCS-GS-153 Square Classic Gypsy Flat Cut Golden Series Screw	1150/-	1250/-

21	Code	Bright	Matt
	SCCT-SEFC-GS-153 Square Ezee Flat Cut Golden Series	1050/-	1150/-
	SCCT-SEFCH-GS-153 Square Ezee Flat Cut Golden Series Hinge	1150/-	1250/-
	SCCT-SEFCS-GS-153 Square Ezee Flat Cut Golden Series Screw	1150/-	1250/-

22	Code	Bright	Matt
	SCCT-SEGFC-GS-153 Square Ezee Gypsy Flat Cut Golden Series	1050/-	1150/-
	SCCT-SEGFCH-GS-153 Square Ezee Gypsy Flat Cut Golden Series Hinge	1150/-	1250/-
	SCCT-SEGFCS-GS-153 Square Ezee Gypsy Flat Cut Golden Series Screw	1150/-	1250/-

SCCT GOLDEN SERIES

SQUARE

HSN Code: 7326.90.30

AISI 304 (18/8) Stainless Steel

Price Per Pc. in INR

23	Code	Bright	Matt
	SCCT-SCLFC-GS-153 Square Clean Line Flat Cut Golden Series	1050/-	1150/-
	SCCT-SCLFCH-GS-153 Square Clean Line Flat Cut Hinge Golden Series	1150/-	1250/-
	SCCT-SCLFCS-GS-153 Square Clean Line Flat Cut Screw Golden Series	1150/-	1250/-

24	Code	Bright	Matt
	SCCT-SCLGFC-GS-153 Square Clean Line Gypsy Flat Cut Golden Series	1050/-	1150/-
	SCCT-SCLGFCH-GS-153 Square Clean Line Gypsy Flat Cut Hinge Golden Series	1150/-	1250/-
	SCCT-SCLGFCS-GS-153 Square Clean Line Gypsy Flat Cut Screw Golden Series	1150/-	1250/-

25	Code	Bright	Matt
	SCCT-SVFC-GS-153 Square Vertical Flat Cut Golden Series	1050/-	1150/-
	SCCT-SVFCH-GS-153 Square Vertical Flat Cut Golden Series Hinge	1150/-	1250/-
	SCCT-SVFCS-GS-153 Square Vertical Flat Cut Golden Series Screw	1150/-	1250/-

26	Code	Bright	Matt
	SCCT-SVGFC-GS-153 Square Vertical Gypsy Flat Cut Golden Series	1050/-	1150/-
	SCCT-SVGFCH-GS-153 Square Vertical Gypsy Flat Cut Golden Series Hinge	1150/-	1250/-
	SCCT-SVGFCS-GS-153 Square Vertical Gypsy Flat Cut Golden Series Screw	1150/-	1250/-

27	Code	Bright	Matt
	SCCT-SZFC-GS-153 Square Zoom Flat Cut Golden Series	1050/-	1150/-
	SCCT-SZFCH-GS-153 Square Zoom Flat Cut Golden Series Hinge	1150/-	1250/-
	SCCT-SZFCS-GS-153 Square Zoom Flat Cut Golden Series Screw	1150/-	1250/-

28	Code	Bright	Matt
	SCCT-SZGFC-GS-153 Square Zoom Gypsy Flat Cut Golden Series	1050/-	1150/-
	SCCT-SZGFCH-GS-153 Square Zoom Gypsy Flat Cut Golden Series Hinge	1150/-	1250/-
	SCCT-SZGFCS-GS-153 Square Zoom Gypsy Flat Cut Golden Series Screw	1150/-	1250/-

29	Code	Bright	Matt
	SCCT-SMFC-GS-153 Square Maze Flat Cut Golden Series	1050/-	1150/-
	SCCT-SMFCH-GS-153 Square Maze Flat Cut Golden Series Hinge	1150/-	1250/-
	SCCT-SMFCS-GS-153 Square Maze Flat Cut Golden Series Screw	1150/-	1250/-

30	Code	Bright	Matt
	SCCT-SMGFC-GS-153 Square Maze Gypsy Flat Cut Golden Series	1050/-	1150/-
	SCCT-SMGFCH-GS-153 Square Maze Gypsy Flat Cut Golden Series Hinge	1150/-	1250/-
	SCCT-SMGFCS-GS-153 Square Maze Gypsy Flat Cut Golden Series Screw	1150/-	1250/-

SCCT GOLDEN SERIES

SQUARE

HSN Code: 7326.90.30

AISI 304 (18/8) Stainless Steel

Price Per Pc. in INR

31	Code	Bright	Matt
	SCCT-SRFC-GS-153 Square Ringo Flat Cut Golden Series	1050/-	1150/-
	SCCT-SRFCH-GS-153 Square Ringo Flat Cut Golden Series Hinge	1150/-	1250/-
	SCCT-SRFCS-GS-153 Square Ringo Flat Cut Golden Series Screw	1150/-	1250/-

32	Code	Bright	Matt
	SCCT-SRGFC-GS-153 Square Ringo Gypsy Flat Cut Golden Series	1050/-	1150/-
	SCCT-SRGFCH-GS-153 Square Ringo Gypsy Flat Cut Golden Series Hinge	1150/-	1250/-
	SCCT-SRGFCS-GS-153 Square Ringo Gypsy Flat Cut Golden Series Screw	1150/-	1250/-



PURE GOLD & ROSE GOLD SERIES

HSN Code: 7326.90.30

AISI 304 (18/8) Stainless Steel

Price Per Pc. in INR

1	Code	Gold
	SCDWPG-600 Shower channel Drainer Wave Pure Gold	10,500/-



SIDE HOLE



CENTER HOLE

2	Code	Rose Gold
	SCDCRG-600 Shower channel Drainer Classic Rose Gold	11,500/-



SIDE HOLE



CENTER HOLE

3	Code	Gold
	SCWDPG-300 Shower Channel Wall Drainer Pure Gold	10,500/-

4	Code	Rose Gold
	SCWDRG-300 Shower Channel Wall Drainer Rose Gold	11,500/-

5	Code	Gold
	SCWDPG-600 Shower Channel Wall Drainer Pure Gold	14,500/-

6	Code	Rose Gold
	SCWDRG-600 Shower Channel Wall Drainer Rose Gold	15,500/-

7	Code	Gold
	SCWDPG-900 Shower Channel Wall Drainer Pure Gold	19,500/-

8	Code	Rose Gold
	SCWDRG-900 Shower Channel Wall Drainer Rose Gold	20,500/-





PURE GOLD & ROSE GOLD SERIES

SQUARE

HSN Code: 7326.90.30

AISI 304 (18/8) Stainless Steel

Price Per Pc. in INR

9	Code	Gold
	SCCT-SEFC-GS-PG-127 Square eze Flat Cut Golden Series Pure Gold	2050/-
11	Code	Gold
	TOF-SEFC-GS-PG-127 Square eze Flat Cut Golden Series Pure Gold	1700/-
13	Code	Gold
	SCCT-SEFC-GS-PG-153 Square eze Flat Cut Golden Series Pure Gold	2350/-
15	Code	Gold
	TOF-SEFC-GS-PG-153 Square eze Flat Cut Golden Series Pure Gold	2000/-
17	Code	Gold
	SCCT-LS-PG-150 Lifestyle Square Pure Gold With Hidden Hinge	2650/-

10	Code	Rose Gold
	SCCT-SEFC-GS-RG-127 Square eze Flat Cut Golden Series Rose Gold	2250/-
12	Code	Rose Gold
	TOF-SEFC-GS-RG-127 Square eze Flat Cut Golden Series Rose Gold	1900/-
14	Code	Rose Gold
	SCCT-SEFC-GS-RG-153 Square eze Flat Cut Golden Series Rose Gold	2600/-
16	Code	Rose Gold
	TOF-SEFC-GS-RG-153 Square eze Flat Cut Golden Series Rose Gold	2250/-
18	Code	Rose Gold
	SCCT-LS-RG-140 Lifestyle Square Rose Gold With Hidden Hinge	2950/-

PURE GOLD & ROSE GOLD SERIES

SQUARE

HSN Code: 7326.90.30

AISI 304 (18/8) Stainless Steel

Price Per Pc. in INR

19	Code	Gold
	IKLS-PG-150 India King Lifestyle Square Pure Gold With Hidden Hinge	2350/-

20	Code	Rose Gold
	IKLS-RG-150 India King Lifestyle Square Rose Gold With Hidden Hinge	2650/-

21	Code	Gold
	SCCT-SP-PG-125 Square Platino Pure Gold Brass	3500/-

22	Code	Rose Gold
	SCCT-SP-RG-125 Square Platino Rose Gold Brass	3800/-

23	Code	Gold
	SP-PG-125 Square Platino Pure Gold Brass	3150/-

24	Code	Rose Gold
	SP-RG-125 Square Platino Rose Gold Brass	3450/-

25	Code	Gold
	SCCT-SP-PG-150 Square Platino Pure Gold Brass	4100/-

26	Code	Rose Gold
	SCCT-SP-RG-150 Square Platino Rose Gold Brass	4400/-

27	Code	Gold
	SP-PG-150 Square Platino Pure Gold Brass	3750/-

28	Code	Rose Gold
	SP-RG-150 Square Platino Rose Gold Brass	4050/-

PURE GOLD & ROSE GOLD SERIES

SQUARE

HSN Code: 7326.90.30

AISI 304 (18/8) Stainless Steel

Price Per Pc. in INR

29	Code	Gold
	FDPS-PG-125 Floor Drain Pop up Square Pure Gold	2200/-

30	Code	Rose Gold
	FDPS-RG-125 Floor Drain Pop up Square Rose Gold	2500/-

31	Code	Gold
	FDPS-PG-150 Floor Drain Pop up Square Pure Gold	2350/-

32	Code	Rose Gold
	FDPS-RG-150 Floor Drain Pop up Square Rose Gold	2650/-

HSN Code: SS-7324.90.00

HSN Code: BRASS 7418.20.10

AISI 304 (18/8) Stainless Steel

Price Per Pc. in INR

33	Code	Gold
	WC-PG-32 Waste Coupling Pure Gold	850/-

34	Code	Rose Gold
	WC-RG-32 Waste Coupling Rose Gold	900/-

35	Code	Gold
	WC-POP-PG-32 Waste Coupling Pop Up Pure Gold Brass	1850/-

36	Code	Rose Gold
	WC-POP-RG-32 Waste Coupling Pop Up Rose Gold Brass	2150/-

37	Code	Gold
	WC-PG-150 Waste Coupling Pure Gold 6"	1350/-

38	Code	Rose Gold
	WC-RG-150 Waste Coupling Rose Gold 6"	1550/-

PURE GOLD & ROSE GOLD SERIES

HSN Code: SS-7324.90.00 HSN Code: BRASS 7418.20.10 AISI 304 (18/8) Stainless Steel Price Per Pc. in INR

39	Code	Gold
	WC-POP-PG-150 Waste Coupling Pop Up Pure Gold 6" Brass	2450/-

40	Code	Rose Gold
	WC-POP-RG-150 Waste Coupling Pop Up Rose Gold 6" Brass	2850/-

HSN Code: 7307.21.00

Price Per Pc. in INR

41	Code	Gold
	GM-PG-001 German Flange Pure Gold	210/-

42	Code	Rose Gold
	GM-RG-001 German Flange Rose Gold	265/-

43	Code	Gold
	SSF-PG-001 Square Small Flange Pure Gold	210/-

44	Code	Rose Gold
	SSF-RG-001 Square Small Flange Rose Gold	265/-

45	Code	Gold
	SBF-PG-002 Square Big Flange Pure Gold	310/-

46	Code	Rose Gold
	SBF-RG-002 Square Big Flange Rose Gold	385/-

TILE DRAINER

SQUARE

HSN Code: 7326.90.30

AISI 304 (18/8) Stainless Steel

Price Per Pc. in INR



5 X 5 & 6 X 6



**5 X 5, 6 X 6,
8 X 8 & 12 X 12**



4 X 4, 5 X 5 & 6 X 6



4 X 4

1	Code	Bright	Matt
	SCCT-STD-125 Square Tile Drainer	1800/-	2000/-

2	Code	Bright	Matt
	SCCT-STD-LI-125 Square Tile Drainer Lite	1600/-	1800/-

3	Code	Bright	Matt
	STD-125 Square Tile Drainer	1400/-	1600/-

4	Code	Bright	Matt
	SCCT-STD-150 Square Tile Drainer	2100/-	2300/-

5	Code	Bright	Matt
	SCCT-STD-LI-150 Square Tile Drainer Lite	1900/-	2100/-

6	Code	Bright	Matt
	STD-150 Square Tile Drainer	1700/-	1900/-

TILE DRAINER

SQUARE

HSN Code: 7326.90.30

AISI 304 (18/8) Stainless Steel

Price Per Pc. in INR

7	Code	Bright	Matt
	SCCT-STD-LI-200 Square Tile Drainer Lite	6799/-	7099/-

8	Code	Bright	Matt
	SCCT-STD-LI-300 Square Tile Drainer Lite	10,499/-	10,799/-

9	Code	Bright	Matt
	SCCT-STD-100 Square Tile Drainer	1600/-	1800/-

10	Code	Bright	Matt
	STD-100 Square Tile Drainer	1300/-	1400/-

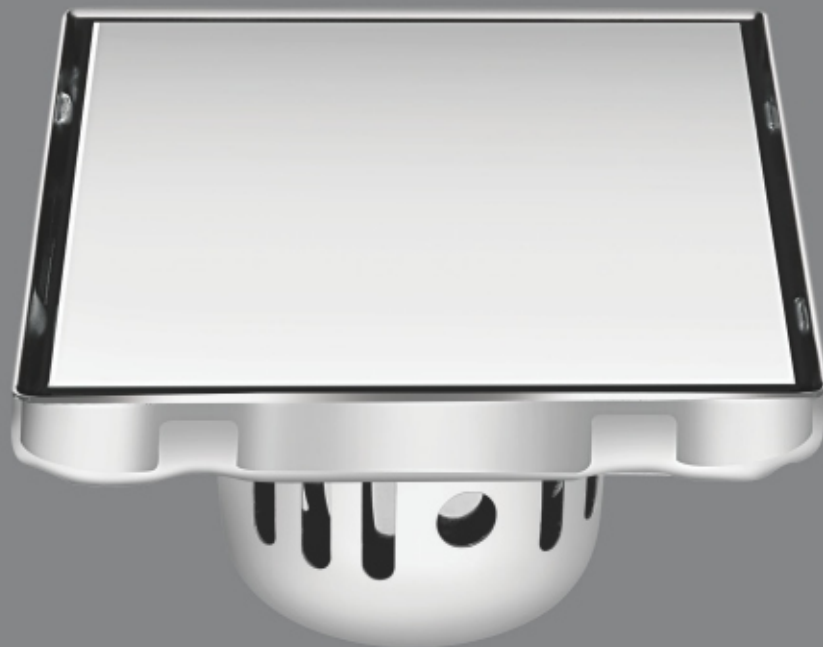

TILE DRAINER

ROUND & CORNER

HSN Code: 7326.90.30

AISI 304 (18/8) Stainless Steel

Price Per Pc. in INR



1	Code	Bright	Matt
	Tile Drainer Round Size 138mm	1800/-	2000/-



2	Code	Bright	Matt
	Tile Drainer Corner	2100/-	2300/-

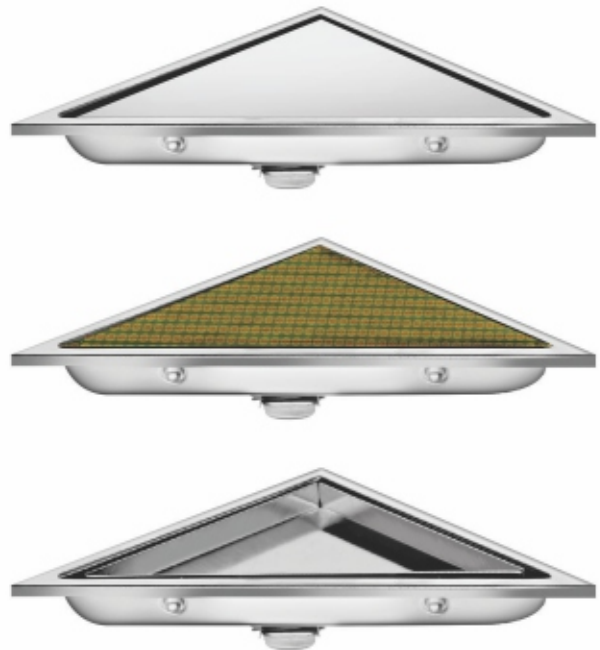

ONEX SERIES

SQUARE

HSN Code: 7326.90.30

AISI 304 (18/8) Stainless Steel

Price Per Pc. in INR

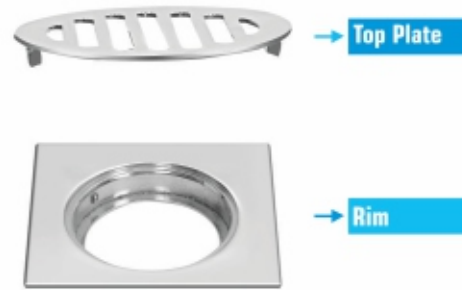

IN 4MM THICKNESS

MID HEAVY DUTY

1	Code	Bright	Matt
	SCCT-S0-125 Square Onex With Hidden Lock System	2200/-	2300/-

2	Code	Bright	Matt
	S0-125 Square Onex With Hidden Lock System	1850/-	1950/-

3	Code	Bright	Matt
	SCCT-S0-150 Square Onex With Hidden Lock System	2400/-	2500/-

4	Code	Bright	Matt
	S0-150 Square Onex With Hidden Lock System	2050/-	2150/-



SCCT HEAVY TRAFFIC

SQUARE & ROUND

HSN Code: 7326.90.30

AISI 304 (18/8) Stainless Steel

Price Per Pc. in INR

**IN 12MM THICKNESS
SUPER HEAVY DUTY**



1	Code	Bright	Matt
	SCCT-SHT-100 Square Heavy Traffic	5200/-	5400/-

2	Code	Bright	Matt
	SCCT-SHT-127 Square Heavy Traffic	6000/-	6200/-

3	Code	Bright	Matt
	SCCT-RHT-127 Round Heavy Traffic	5300/-	5500/-

4	Code	Bright	Matt
	SCCT-SHT-150 Square Heavy Traffic	7000/-	7200/-

5	Code	Bright	Matt
	SCCT-SHT-200 Square Heavy Traffic	20000/-	20500/-

6	Code	Bright	Matt
	SCCT-SHT-250 Square Heavy Traffic	25000/-	25500/-

7	Code	Bright	Matt
	SCCT-SHT-300 Square Heavy Traffic	29000/-	29500/-

SCCT LITE

SQUARE

HSN Code: 7326.90.30

AISI 304 (18/8) Stainless Steel

Price Per Pc. in INR



1	Code	Bright	Matt
	SCCT-SFC-LI-127 Square Lite Flat Cut	630/-	730/-
	SCCT-SFCH-LI-127 Square Lite Flat Cut Hinge	730/-	830/-
	SCCT-SFCS-LI-127 Square Lite Flat Cut Screw	730/-	830/-
	SCCT-SFCL-LI-127 Square Lite Flat Cut Lock	680/-	780/-

2	Code	Bright	Matt
	SCCT-SGFC-LI-127 Square Lite Gypsy Flat Cut	630/-	730/-
	SCCT-SGFCH-LI-127 Square Lite Gypsy Flat Cut Hinge	730/-	830/-
	SCCT-SGFCS-LI-127 Square Lite Gypsy Flat Cut Screw	730/-	830/-
	SCCT-SGFCL-LI-127 Square Lite Gypsy Flat Cut Lock	680/-	780/-

3	Code	Bright	Matt
	SCCT-SCFC-LI-127 Square Lite Classic Flat Cut	730/-	830/-
	SCCT-SCFCH-LI-127 Square Lite Classic Flat Cut Hinge	830/-	930/-
	SCCT-SCFCS-LI-127 Square Lite Classic Flat Cut Screw	830/-	930/-
	SCCT-SCFCL-LI-127 Square Lite Classic Flat Cut Lock	780/-	880/-

4	Code	Bright	Matt
	SCCT-SCGFC-LI-127 Square Lite Classic Gypsy Flat Cut	730/-	830/-
	SCCT-SCGFCH-LI-127 Square Lite Classic Gypsy Flat Cut Hinge	830/-	930/-
	SCCT-SCGFCS-LI-127 Square Lite Classic Gypsy Flat Cut Screw	830/-	930/-
	SCCT-SCGFCL-LI-127 Square Lite Classic Gypsy Flat Cut Lock	780/-	880/-

5	Code	Bright	Matt
	SCCT-SRFC-LI-127 Square Lite Ringo Flat Cut	730/-	830/-
	SCCT-SRFCH-LI-127 Square Lite Ringo Flat Cut Hinge	830/-	930/-
	SCCT-SRFCS-LI-127 Square Lite Ringo Flat Cut Screw	830/-	930/-
	SCCT-SRFCL-LI-127 Square Lite Ringo Flat Cut Lock	780/-	880/-

6	Code	Bright	Matt
	SCCT-SEFC-LI-127 Square Lite Ezee Flat Cut	730/-	830/-
	SCCT-SEFCH-LI-127 Square Lite Ezee Flat Cut Hinge	830/-	930/-
	SCCT-SEFCS-LI-127 Square Lite Ezee Flat Cut Screw	830/-	930/-
	SCCT-SEFCL-LI-127 Square Lite Ezee Flat Cut Lock	780/-	880/-

SCCT LITE

SQUARE

HSN Code: 7326.90.30

AISI 304 (18/8) Stainless Steel

Price Per Pc. in INR

7	Code	Bright	Matt
	SCCT-SEGFC-LI-127 Square Lite Ezee Gypsy Flat Cut	730/-	830/-
	SCCT-SEGFCFH-LI-127 Square Lite Ezee Gypsy Flat Cut Hinge	830/-	930/-
	SCCT-SEGFCFS-LI-127 Square Lite Ezee Gypsy Flat Cut Screw	830/-	930/-
	SCCT-SEGFCFL-LI-127 Square Lite Ezee Gypsy Flat Cut Lock	780/-	880/-

8	Code	Bright	Matt
	SCCT-SFC-LI-153 Square Lite Flat Cut	730/-	830/-
	SCCT-SFCH-LI-153 Square Lite Flat Cut Hinge	830/-	930/-
	SCCT-SFCS-LI-153 Square Lite Flat Cut Screw	830/-	930/-
	SCCT-SFCL-LI-153 Square Lite Flat Cut Lock	780/-	880/-

9	Code	Bright	Matt
	SCCT-SGFC-LI-153 Square Lite Gypsy Flat Cut	730/-	830/-
	SCCT-SGFCFH-LI-153 Square Lite Gypsy Flat Cut Hinge	830/-	930/-
	SCCT-SGFCFS-LI-153 Square Lite Gypsy Flat Cut Screw	830/-	930/-
	SCCT-SGFCFL-LI-153 Square Lite Gypsy Flat Cut Lock	780/-	880/-

10	Code	Bright	Matt
	SCCT-SCFC-LI-153 Square Lite Classic Flat Cut	830/-	930/-
	SCCT-SCFCFH-LI-153 Square Lite Classic Flat Cut Hinge	930/-	1030/-
	SCCT-SCFCFS-LI-153 Square Lite Classic Flat Cut Screw	930/-	1030/-
	SCCT-SCFCFL-LI-153 Square Lite Classic Flat Cut Lock	880/-	980/-

11	Code	Bright	Matt
	SCCT-SCGFC-LI-153 Square Lite Classic Gypsy Flat Cut	830/-	930/-
	SCCT-SCGFCFH-LI-153 Square Lite Classic Gypsy Flat Cut Hinge	930/-	1030/-
	SCCT-SCGFCFS-LI-153 Square Lite Classic Gypsy Flat Cut Screw	930/-	1030/-
	SCCT-SCGFCFL-LI-153 Square Lite Classic Gypsy Flat Cut Lock	880/-	980/-

12	Code	Bright	Matt
	SCCT-SRFC-LI-153 Square Lite Ringo Flat Cut	830/-	930/-
	SCCT-SRFCFH-LI-153 Square Lite Ringo Flat Cut Hinge	930/-	1030/-
	SCCT-SRFCFS-LI-153 Square Lite Ringo Flat Cut Screw	930/-	1030/-
	SCCT-SRFCFL-LI-153 Square Lite Ringo Flat Cut Lock	880/-	980/-

13	Code	Bright	Matt
	SCCT-SEFC-LI-153 Square Lite Ezee Flat Cut	830/-	930/-
	SCCT-SEFCFH-LI-153 Square Lite Ezee Flat Cut Hinge	930/-	1030/-
	SCCT-SEFCFS-LI-153 Square Lite Ezee Flat Cut Screw	930/-	1030/-
	SCCT-SEFCFL-LI-153 Square Lite Ezee Flat Cut Lock	880/-	980/-

14	Code	Bright	Matt
	SCCT-SEGFC-LI-153 Square Lite Ezee Gypsy Flat Cut	830/-	930/-
	SCCT-SEGFCFH-LI-153 Square Lite Ezee Gypsy Flat Cut Hinge	930/-	1030/-
	SCCT-SEGFCFS-LI-153 Square Lite Ezee Gypsy Flat Cut Screw	930/-	1030/-
	SCCT-SEGFCFL-LI-153 Square Lite Ezee Gypsy Flat Cut Lock	830/-	930/-

SCCT LITE

ROUND

HSN Code: 7326.90.30

AISI 304 (18/8) Stainless Steel

Price Per Pc. in INR



1	Code	Bright	Matt
	SCCT-R-LI-127 Round Lite	570/-	670/-
	SCCT-RH-LI-127 Round Lite Hinge	670/-	770/-
	SCCT-RS-LI-127 Round Lite Screw	670/-	770/-
	SCCT-RL-LI-127 Round Lite Lock	620/-	720/-

2	Code	Bright	Matt
	SCCT-RG-LI-127 Round Gypsy Lite	570/-	670/-
	SCCT-RGH-LI-127 Round Gypsy Lite Hinge	670/-	770/-
	SCCT-RGS-LI-127 Round Gypsy Lite Screw	670/-	770/-
	SCCT-RGL-LI-127 Round Gypsy Lite Lock	620/-	720/-

3	Code	Bright	Matt
	SCCT-RC-LI-127 Round Classic Lite	670/-	770/-
	SCCT-RCH-LI-127 Round Classic Lite Hinge	770/-	870/-
	SCCT-RCS-LI-127 Round Classic Lite Screw	770/-	870/-
	SCCT-RCL-LI-127 Round Classic Lite Lock	720/-	820/-

4	Code	Bright	Matt
	SCCT-RCG-LI-127 Round Classic Gypsy Lite	670/-	770/-
	SCCT-RCGH-LI-127 Round Classic Gypsy Lite Hinge	770/-	870/-
	SCCT-RCGS-LI-127 Round Classic Gypsy Lite Screw	770/-	870/-
	SCCT-RCGL-LI-127 Round Classic Gypsy Lite Lock	720/-	820/-

5	Code	Bright	Matt
	SCCT-RR-LI-127 Round Ringo Lite	670/-	770/-
	SCCT-RRH-LI-127 Round Ringo Lite Hinge	770/-	870/-
	SCCT-RRS-LI-127 Round Ringo Lite Screw	770/-	870/-
	SCCT-RRL-LI-127 Round Ringo Lite Lock	720/-	820/-

6	Code	Bright	Matt
	SCCT-RE-LI-127 Round Ezee Lite	670/-	770/-
	SCCT-REH-LI-127 Round Ezee Lite Hinge	770/-	870/-
	SCCT-RES-LI-127 Round Ezee Lite Screw	770/-	870/-
	SCCT-REL-LI-127 Round Ezee Lite Lock	720/-	820/-

7	Code	Bright	Matt
	SCCT-REG-LI-127 Round Ezee Gypsy Lite	670/-	770/-
	SCCT-REGH-LI-127 Round Ezee Gypsy Lite Hinge	770/-	870/-
	SCCT-REGS-LI-127 Round Ezee Gypsy Lite Screw	770/-	870/-
	SCCT-REGL-LI-127 Round Ezee Gypsy Lite Lock	720/-	820/-

POP UP DRAIN

SQUARE & ROUND

HSN Code: 7326.90.30

AISI 304 (18/8) Stainless Steel

Price Per Pc. in INR



1	Code	Bright	Matt
	FLOOR DRAIN POP UP ROUND 120 FDPR 120	710/-	810/-

2	Code	Bright	Matt
	FLOOR DRAIN POP UP SQUARE 100 FDPS 100	650/-	750/-

3	Code	Bright	Matt
	FLOOR DRAIN POP UP SQUARE 120 FDPS 120	810/-	910/-

4	Code	Bright	Matt
	FLOOR DRAIN POP UP SQUARE 150 FDPS 150	910/-	1010/-

EXOTIC SERIES & FCT

HSN Code: 7326.90.30

Price Per Pc. in INR

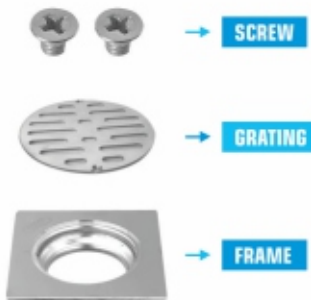

1	Code	Bright	Matt
	EKS- 80 Exotic Screw 80 With Screw	240/-	260/-

2	Code	Bright	Matt
	EKS- 100 Exotic Screw 100 With Screw	300/-	320/-

3	Code	Bright	Matt
	EKS- 150 Exotic Screw 150 With Screw	650/-	700/-

4	Code	Bright	Matt
	EXW- 125 Exotic Wave 125 With Hidden Lock	550/-	650/-

5	Code	Bright	Matt
	EXR- 125 Exotic Ringlet 125 With Hidden Lock	550/-	650/-

6	Code	Bright	Matt
	FCT R 100 FCT Round 100 With Lock	610/-	710/-



EXOTIC SERIES & FCT

HSN Code: 7326.90.30

Price Per Pc. in INR

7	Code	Bright	Matt
	FCT-R-120 FCT Round 120 With Lock	710/-	810/-

8	Code	Bright	Matt
	FCT-S-100 FCT Square 100 With Lock	680/-	780/-

9	Code	Bright	Matt
	FCT-SS-100 FCT Square Star 100	700/-	800/-

HSN Code: 7326.90.30

AISI 304 (18/8) Stainless Steel

Price Per Pc. in INR

10	Code	Bright	Matt
	EXF-150 Exotic Flato 150	1050/-	1200/-



SHOWER CHANNEL WALL DRAIN

WALL DRAINER

HSN Code: 7326.90.30

AISI 304 (18/8) Stainless Steel

Price Per Pc. in INR



Model Code	Model Name	Size in INCH	Size in MM	Bright	Matt
SCWD 900	SHOWER CHANNEL WALL DRAIN 900 MM	3.5 X 36	90 X 900	15,000/-	16,000/-
SCWD 600	SHOWER CHANNEL WALL DRAIN 600 MM	3.5 X 24	90 X 600	12,000/-	13,000/-
SCWD 300	SHOWER CHANNEL WALL DRAIN 300 MM	3.5 X 12	90 X 300	9,000/-	10,000/-



SHOWER CHANNEL WAVE

WAVE

HSN Code: 7326.90.30

AISI 304 (18/8) Stainless Steel

Price Per Pc. in INR

OPEN



CLOSE

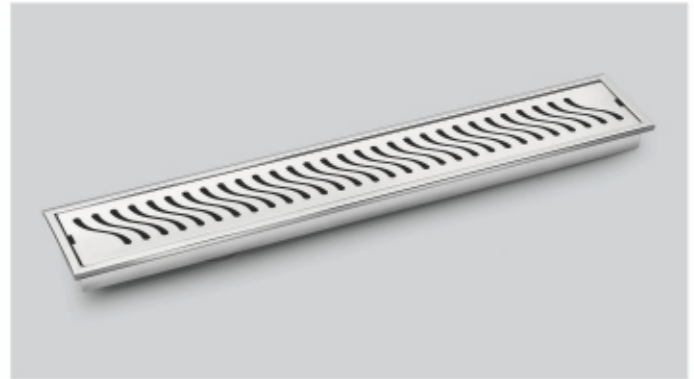

Model Code	Model Name	Size in INCH	Size in MM	Bright	Matt
SCDW 1000	SHOWER CHANNEL WAVE 1000 mm	4 x 40	100 x 1000	8100/-	8300/-
SCDW 900	SHOWER CHANNEL WAVE 900 mm	4 x 36	100 x 900	7600/-	7800/-
SCDW 800	SHOWER CHANNEL WAVE 800 mm	4 x 32	100 x 800	7600/-	7800/-
SCDW 600	SHOWER CHANNEL WAVE 600 mm	4 x 24	100 x 600	7000/-	7200/-
SCDW 450	SHOWER CHANNEL WAVE 450 mm	4 x 18	100 x 450	6000/-	6200/-
SCDW 300	SHOWER CHANNEL WAVE 300 mm	4 x 12	100 x 300	5000/-	5200/-



SIDE HOLE



CENTER HOLE

SHOWER CHANNEL CLASSIC

CLASSIC

HSN Code: 7326.90.30

AISI 304 (18/8) Stainless Steel

Price Per Pc. in INR

OPEN

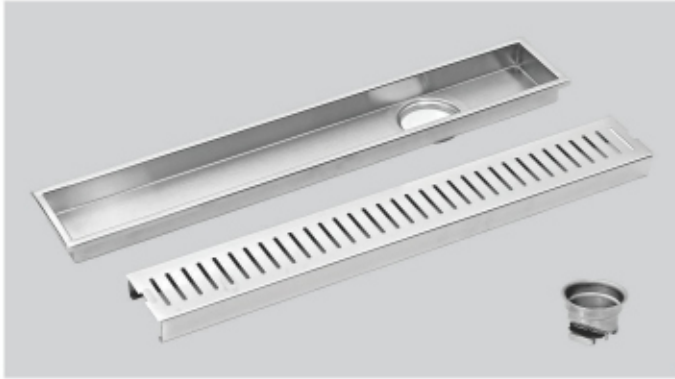

CLOSE

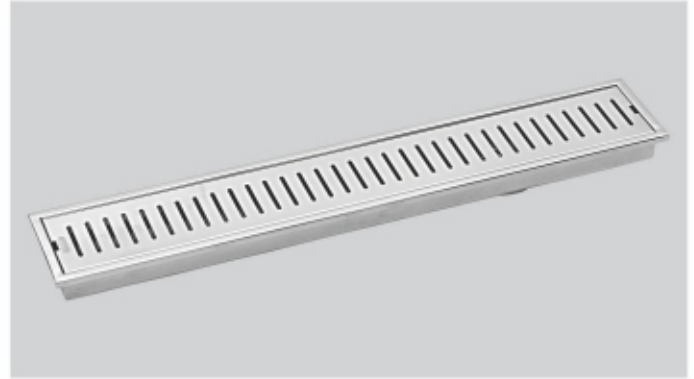

Model Code	Model Name	Size in INCH	Size in MM	Bright	Matt
SCDC 1000	SHOWER CHANNEL CLASSIC 1000 mm	4 x 40	100 x 1000	8100/-	8300/-
SCDC 900	SHOWER CHANNEL CLASSIC 900 mm	4 x 36	100 x 900	7600/-	7800/-
SCDC 800	SHOWER CHANNEL CLASSIC 800 mm	4 x 32	100 x 800	7600/-	7800/-
SCDC 600	SHOWER CHANNEL CLASSIC 600 mm	4 x 24	100 x 600	7000/-	7200/-
SCDC 450	SHOWER CHANNEL CLASSIC 450 mm	4 x 18	100 x 450	6000/-	6200/-
SCDC 300	SHOWER CHANNEL CLASSIC 300 mm	4 x 12	100 x 300	5000/-	5200/-



SIDE HOLE



CENTER HOLE

SHOWER CHANNEL LINEAR

LINEAR

HSN Code: 7326.90.30

AISI 304 (18/8) Stainless Steel

Price Per Pc. in INR

OPEN



CLOSE

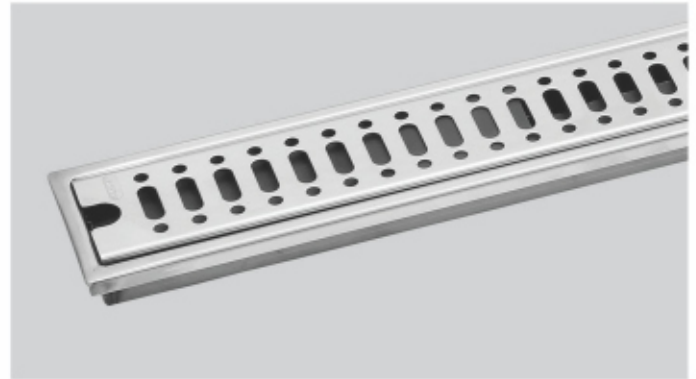

Model Code	Model Name	Size in INCH	Size in MM	Bright	Matt
SCDL 1200	SHOWER CHANNEL LINEAR 1200 mm	3 x 48	75 x 1200	7000/-	7200/-
SCDL 1000	SHOWER CHANNEL LINEAR 1000 mm	3 x 40	75 x 1000	7000/-	7200/-
SCDL 900	SHOWER CHANNEL LINEAR 900 mm	3 x 36	75 x 900	6400/-	6600/-
SCDL 800	SHOWER CHANNEL LINEAR 800 mm	3 x 32	75 x 800	6400/-	6600/-
SCDL 700	SHOWER CHANNEL LINEAR 700 mm	3 x 28	75 x 700	5500/-	5700/-
SCDL 600	SHOWER CHANNEL LINEAR 600 mm	3 x 24	75 x 600	4600/-	4800/-
SCDL 300	SHOWER CHANNEL LINEAR 300 mm	3 x 12	75 x 300	3000/-	3200/-



ONLY CENTER HOLE

SHOWER CHANNEL CLEAN LINE

CLEAN LINE

HSN Code: 7326.90.30

AISI 304 (18/8) Stainless Steel

Price Per Pc. in INR

OPEN



CLOSE



Model Code	Model Name	Size in INCH	Size in MM	Bright	Matt
SCDCL 1000	SHOWER CHANNEL CLEAN LINE 1000 mm	4 x 40	100 x 1000	8600/-	8800/-
SCDCL 900	SHOWER CHANNEL CLEAN LINE 900 mm	4 x 36	100 x 900	8100/-	8300/-
SCDCL 800	SHOWER CHANNEL CLEAN LINE 800 mm	4 x 32	100 x 800	8100/-	8300/-
SCDCL 600	SHOWER CHANNEL CLEAN LINE 600 mm	4 x 24	100 x 600	7500/-	7700/-
SCDCL 450	SHOWER CHANNEL CLEAN LINE 450 mm	4 x 18	100 x 450	6500/-	6700/-
SCDCL 300	SHOWER CHANNEL CLEAN LINE 300 mm	4 x 12	100 x 300	5500/-	5700/-



SIDE HOLE



CENTER HOLE

SHOWER CHANNEL TILE DRAINER

TILE DRAINER

HSN Code: 7326.90.30

AISI 304 (18/8) Stainless Steel

Price Per Pc. in INR

OPEN



CLOSE



Model Code	Model Name	Size in INCH	Size in MM	Bright	Matt
SCDTD 1000	SHOWER CHANNEL TILE DRAINER 1000 mm	4 x 40	100 x 1000	8600/-	8800/-
SCDTD 900	SHOWER CHANNEL TILE DRAINER 900 mm	4 x 36	100 x 900	8100/-	8300/-
SCDTD 800	SHOWER CHANNEL TILE DRAINER 800 mm	4 x 32	100 x 800	8100/-	8300/-
SCDTD 600	SHOWER CHANNEL TILE DRAINER 600 mm	4 x 24	100 x 600	7500/-	7700/-
SCDTD 450	SHOWER CHANNEL TILE DRAINER 450 mm	4 x 18	100 x 450	6500/-	6700/-
SCDTD 300	SHOWER CHANNEL TILE DRAINER 300 mm	4 x 12	100 x 300	5500/-	5700/-



SIDE HOLE



CENTER HOLE

SHOWER CHANNEL SHARP

SHARP

HSN Code: 7326.90.30

AISI 304 (18/8) Stainless Steel

Price Per Pc. in INR

OPEN

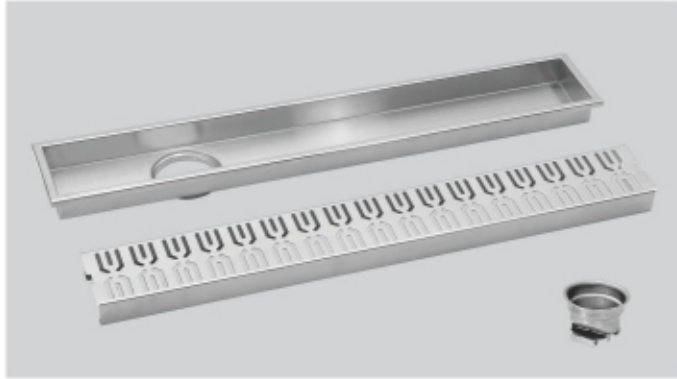

CLOSE

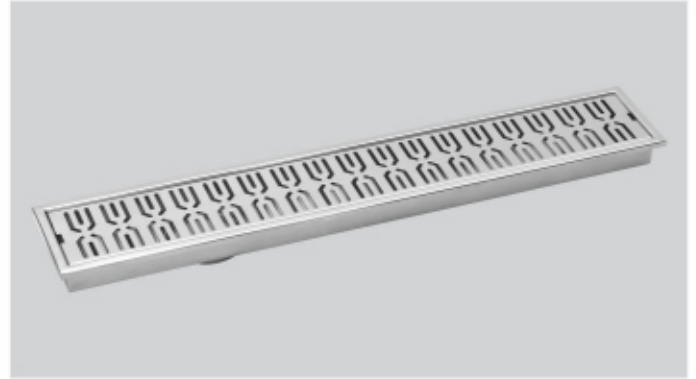

Model Code	Model Name	Size in INCH	Size in MM	Bright	Matt
SCDS 1000	SHOWER CHANNEL SHARP 1000 mm	4 x 40	100 x 1000	8100/-	8300/-
SCDS 900	SHOWER CHANNEL SHARP 900 mm	4 x 36	100 x 900	7600/-	7800/-
SCDS 800	SHOWER CHANNEL SHARP 800 mm	4 x 32	100 x 800	7600/-	7800/-
SCDS 600	SHOWER CHANNEL SHARP 600 mm	4 x 24	100 x 600	7000/-	7200/-
SCDS 450	SHOWER CHANNEL SHARP 450 mm	4 x 18	100 x 450	6000/-	6200/-
SCDS 300	SHOWER CHANNEL SHARP 300 mm	4 x 12	100 x 300	5000/-	5200/-



SIDE HOLE



CENTER HOLE

SHOWER CHANNEL SQUARE

SQUARE

HSN Code: 7326.90.30

AISI 304 (18/8) Stainless Steel

Price Per Pc. in INR

OPEN

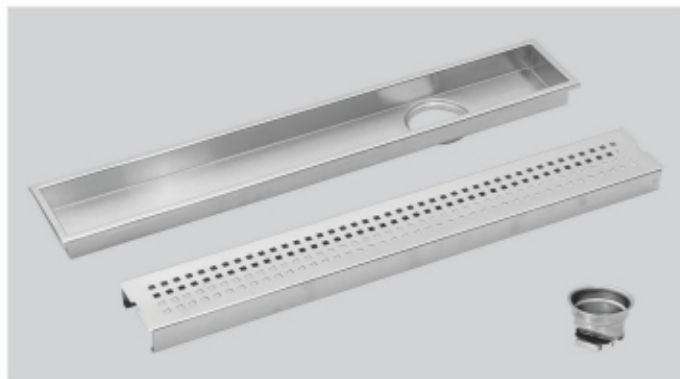

CLOSE

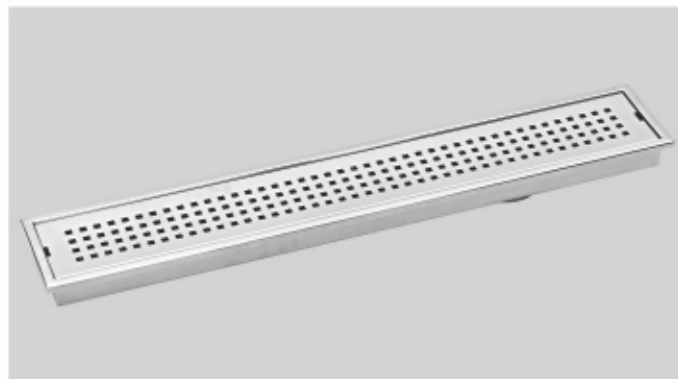

Model Code	Model Name	Size in INCH	Size in MM	Bright	Matt
SCDSQ 1000	SHOWER CHANNEL SQUARE 1000 mm	4 x 40	100 x 1000	8100/-	8300/-
SCDSQ 900	SHOWER CHANNEL SQUARE 900 mm	4 x 36	100 x 900	7600/-	7800/-
SCDSQ 800	SHOWER CHANNEL SQUARE 800 mm	4 x 32	100 x 800	7600/-	7800/-
SCDSQ 600	SHOWER CHANNEL SQUARE 600 mm	4 x 24	100 x 600	7000/-	7200/-
SCDSQ 450	SHOWER CHANNEL SQUARE 450 mm	4 x 18	100 x 450	6000/-	6200/-
SCDSQ 300	SHOWER CHANNEL SQUARE 300 mm	4 x 12	100 x 300	5000/-	5200/-



SIDE HOLE



CENTER HOLE

SHOWER CHANNEL NEO

NEO

HSN Code: 7326.90.30

AISI 304 (18/8) Stainless Steel

Price Per Pc. in INR

OPEN



CLOSE



Model Code	Model Name	Size in INCH	Size in MM	Bright	Matt
SCDN 1000	SHOWER CHANNEL NEO 1000 mm	4 x 40	100 x 1000	8100/-	8300/-
SCDN 900	SHOWER CHANNEL NEO 900 mm	4 x 36	100 x 900	7600/-	7800/-
SCDN 800	SHOWER CHANNEL NEO 800 mm	4 x 32	100 x 800	7600/-	7800/-
SCDN 600	SHOWER CHANNEL NEO 600 mm	4 x 24	100 x 600	7000/-	7200/-
SCDN 450	SHOWER CHANNEL NEO 450 mm	4 x 18	100 x 450	6000/-	6200/-
SCDN 300	SHOWER CHANNEL NEO 300 mm	4 x 12	100 x 300	5000/-	5200/-



SIDE HOLE



CENTER HOLE

SHOWER CHANNEL TILE DRAINER WITHOUT COLLER

TILE DRAINER WITHOUT COLLER HSN Code: 7326.90.30 AISI 304 (18/8) Stainless Steel Price Per Pc. in INR

OPEN



CLOSE



Model Code	Model Name	Size in INCH	Size in MM	Bright	Matt
SCDWCTD 1000	SHOWER CHANNEL TILE DRAINER WITHOUT COLLER 1000 mm	4 x 40	100 x 1000	8600/-	8800/-
SCDWCTD 900	SHOWER CHANNEL TILE DRAINER WITHOUT COLLER 900 mm	4 x 36	100 x 900	8100/-	8300/-
SCDWCTD 800	SHOWER CHANNEL TILE DRAINER WITHOUT COLLER 800 mm	4 x 32	100 x 800	8100/-	8300/-
SCDWCTD 600	SHOWER CHANNEL TILE DRAINER WITHOUT COLLER 600 mm	4 x 24	100 x 600	7500/-	7700/-
SCDWCTD 450	SHOWER CHANNEL TILE DRAINER WITHOUT COLLER 450 mm	4 x 18	100 x 450	6500/-	6700/-
SCDWCTD 300	SHOWER CHANNEL TILE DRAINER WITHOUT COLLER 300 mm	4 x 12	100 x 300	5500/-	5700/-



SIDE HOLE



CENTER HOLE

SHOWER CHANNEL CLEAN LINE WITHOUT COLLER

CLEAN LINE WITHOUT COLLER

HSN Code: 7326.90.30

AISI 304 (18/8) Stainless Steel

Price Per Pc. in INR

OPEN



CLOSE



Model Code	Model Name	Size in INCH	Size in MM	Bright	Matt
SCDCLWC 1000	SHOWER CHANNEL CLEAN LINE WITHOUT COLLER 1000 mm	4 x 40	100 x 1000	8600/-	8800/-
SCDCLWC 900	SHOWER CHANNEL CLEAN LINE WITHOUT COLLER 900 mm	4 x 36	100 x 900	8100/-	8300/-
SCDCLWC 800	SHOWER CHANNEL CLEAN LINE WITHOUT COLLER 800 mm	4 x 32	100 x 800	8100/-	8300/-
SCDCLWC 600	SHOWER CHANNEL CLEAN LINE WITHOUT COLLER 600 mm	4 x 24	100 x 600	7500/-	7700/-
SCDCLWC 450	SHOWER CHANNEL CLEAN LINE WITHOUT COLLER 450 mm	4 x 18	100 x 450	6500/-	6700/-
SCDCLWC 300	SHOWER CHANNEL CLEAN LINE WITHOUT COLLER 300 mm	4 x 12	100 x 300	5500/-	5700/-



SIDE HOLE



CENTER HOLE

ROOF DRAIN

SQUARE & ROUND

HSN Code: 7326.90.30

AISI 304 (18/8) Stainless Steel

Price Per Pc. in INR



1	Code	Bright	Matt
	ROOF DRAIN ROUND NO. 5 RDR 05 With Lock	710/-	810/-

2	Code	Bright	Matt
	ROOF DRAIN SQUARE FLAT CUT No. 5 RDS FC 05 With Lock	830/-	930/-

3	Code	Bright	Matt
	ROOF DRAIN SQUARE FLAT CUT No. 6 RDS FC 06 With Lock	930/-	1030/-

4	Code	Bright	Matt
	ROOF DRAIN ROUND FLAT CUT No. 8 RDR FC 08 With Screw	3500/-	3700/-

5	Code	Bright	Matt
	ROOF DRAIN SQUARE FLAT CUT No. 8 RDS FC 08 With Screw	3900/-	4100/-

6	Code	Bright	Matt
	ROOF DRAIN SQUARE FLAT CUT No. 10 RDS FC 10 With Screw	5200/-	5400/-

7	Code	Bright	Matt
	ROOF DRAIN SQUARE FLAT CUT No. 12 RDS FC 12 With Screw	6800/-	7000/-



ROOF DRAIN CAST

HSN Code: 7325.99.30

CAST IRON & ALUMINUM CAST

Price Per Pc. in INR

FLAT TYPE



Model Code	Model Name	Size in INCH	Price
RDFT-3"	ROOF DRAIN FLAT TYPE	3"	6,000/-
RDFT-4"	ROOF DRAIN FLAT TYPE	4"	8,500/-
RDFT-6"	ROOF DRAIN FLAT TYPE	6"	9,000/-
RDFT-8"	ROOF DRAIN FLAT TYPE	8"	26,000/-
RDFT-10"	ROOF DRAIN FLAT TYPE	10"	31,000/-

DOOM TYPE



Model Code	Model Name	Size in INCH	Price
RDDT-3"	ROOF DRAIN DOOM TYPE	3"	6,500/-
RDDT-4"	ROOF DRAIN DOOM TYPE	4"	9,000/-
RDDT-6"	ROOF DRAIN DOOM TYPE	6"	9,500/-
RDDT-8"	ROOF DRAIN DOOM TYPE	8"	26,500/-
RDDT-10"	ROOF DRAIN DOOM TYPE	10"	31,500/-

PARAPET TYPE



Model Code	Model Name	Size in INCH	Price
RDPT-3"	ROOF DRAIN PARAPET TYPE	3"	7,000/-
RDPT-4"	ROOF DRAIN PARAPET TYPE	4"	9,500/-
RDPT-6"	ROOF DRAIN PARAPET TYPE	6"	11,000/-
RDPT-8"	ROOF DRAIN PARAPET TYPE	8"	27,000/-
RDPT-10"	ROOF DRAIN PARAPET TYPE	10"	41,000/-

INDIA KING

SQUARE & ROUND

HSN Code: 7326.90.30

Price Per Pc. in INR

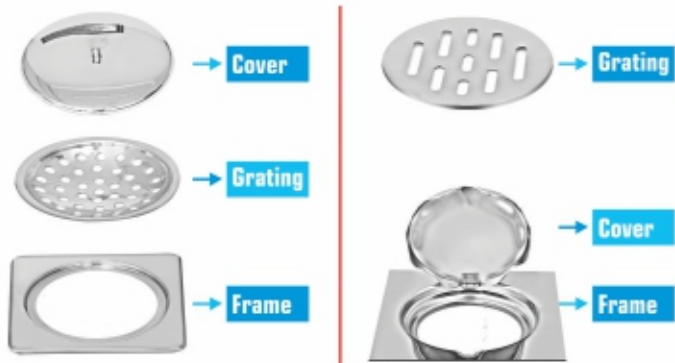

1	Code	Bright	Matt
	INDIA KING ROUND No. 5 IKR 05	350/-	450/-

2	Code	Bright	Matt
	INDIA KING SQUARE FLAT CUT No.5 IKSFC 05	410/-	510/-

3	Code	Bright	Matt
	INDIA KING SQUARE FLAT CUT No.6 IKSFC 06	440/-	540/-

SQUARE & ROUND

HSN Code: 7326.90.30

AISI 304 (18/8) Stainless Steel

Price Per Pc. in INR

4	Code	Bright	Matt
	INDIA KING LIFESTYLE ROUND 138 IKLR 138 With Hidden Hinge	1180/-	1280/-

5	Code	Bright	Matt
	INDIA KING LIFESTYLE ROUND Gypsy 138 IKLRG 138 With Hidden Hinge	1180/-	1280/-

INDIA KING

SQUARE & ROUND

HSN Code: 7326.90.30

AISI 304 (18/8) Stainless Steel

Price Per Pc. in INR

6	Code	Bright	Matt
	INDIA KING LIFESTYLE SQUARE 140 IKLS 140 With Hidden Hinge	1350/-	1450/-

7	Code	Bright	Matt
	INDIA KING LIFESTYLE SQUARE Gypsy 140 IKLSG 140 With Hidden Hinge	1350/-	1450/-

8	Code	Bright	Matt
	INDIA KING LIFESTYLE SQUARE 150 IKLS 150 With Hidden Hinge	1450/-	1550/-

9	Code	Bright	Matt
	INDIA KING LIFESTYLE SQUARE Gypsy 150 IKLSG 150 With Hidden Hinge	1450/-	1550/-



CLEANOUT

SQUARE & ROUND

HSN Code: 7326.90.30

AISI 304 (18/8) Stainless Steel

Price Per Pc. in INR

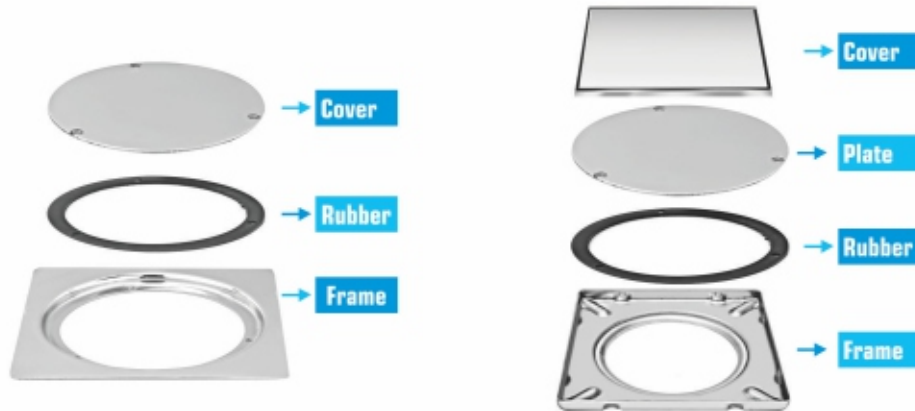

1	Code	Bright	Matt
	CLEANOUT ROUND NO. 3 COR 03	450/-	550/-
	CLEANOUT ROUND HINGE NO. 3 CORH 03	550/-	650/-

2	Code	Bright	Matt
	CLEANOUT ROUND NO. 4 COR 04	550/-	650/-
	CLEANOUT ROUND HINGE NO. 4 CORH 04	650/-	750/-

3	Code	Bright	Matt
	CLEANOUT ROUND NO. 5 COR 05	640/-	740/-
	CLEANOUT ROUND HINGE NO. 5 CORH 05	740/-	840/-

4	Code	Bright	Matt
	CLEANOUT ROUND FLAT CUT NO. 8 COR FC 08	2500/-	2700/-
	CLEANOUT ROUND FLAT CUT HINGE No. 8 COR FCH 08	2600/-	2800/-

5	Code	Bright	Matt
	CLEANOUT SQUARE FLAT CUT NO. 3 COS FC 03	550/-	650/-
	CLEANOUT SQUARE FLAT CUT HINGE No. 3 COS FCH 03	650/-	750/-

6	Code	Bright	Matt
	CLEANOUT SQUARE FLAT CUT NO. 4 COS FC 04	620/-	720/-
	CLEANOUT SQUARE FLAT CUT HINGE No. 4 COS FCH 04	720/-	820/-

CLEANOUT

SQUARE & ROUND

HSN Code: 7326.90.30

AISI 304 (18/8) Stainless Steel

Price Per Pc. in INR

7	Code	Bright	Matt
	CLEANOUT SQUARE FLAT CUT NO. 5 COS FC 05	660/-	760/-
	CLEANOUT SQUARE FLAT CUT HINGE NO. 5 COS FCH 05	760/-	860/-

8	Code	Bright	Matt
	CLEANOUT SQUARE FLAT CUT NO. 6 COS FC 06	750/-	850/-
	CLEANOUT SQUARE FLAT CUT HINGE No. 6 COS FCH 06	850/-	950/-

9	Code	Bright	Matt
	CLEANOUT SQUARE FLAT CUT NO. 8 COS FCH 08	3000/-	3200/-
	CLEANOUT SQUARE FLAT CUT HINGE No. 8 COS FCH 08	3100/-	3300/-

10	Code	Bright	Matt
	CLEANOUT SQUARE No.10 COS 10	4500/-	4700/-
	CLEANOUT SQUARE HINGE No. 10 COS FCH 10	4600/-	4800/-

11	Code	Bright	Matt
	CLEANOUT SQUARE FLAT CUT NO. 12 COS FC 12	6100/-	6300/-
	CLEANOUT SQUARE FLAT CUT HINGE No. 12 COS FCH 12	6200/-	6400/-

12	Code	Bright	Matt
	CLEANOUT SQUARE TILE DRAIN NO. 4 COS TD 04	1200/-	1300/-

13	Code	Bright	Matt
	CLEANOUT SQUARE TILE DRAIN NO. 5 COS TD 05	1500/-	1600/-

14	Code	Bright	Matt
	CLEANOUT SQUARE TILE DRAIN NO. 6 COS TD 06	1800/-	1900/-

15	Code	Bright	Matt
	CLEANOUT SQUARE TILE DRAIN NO.8 COS TD 08	5500/-	5700/-

16	Code	Bright	Matt
	CLEANOUT SQUARE TILE DRAIN NO. 12 COS TD 012	9000/-	9200/-

SANITROKING

SQUARE DOOM TYPE

HSN Code: 7326.90.30

Price 10 Pc. Per Box in INR

1	Code	Bright	Matt
	SANITROKING SQUARE FLAT CUT NO. 3 SKSFC 03	1230/-	1430/-
	SANITROKING SQUARE FLAT CUT HINGE NO. 3 SKSFCH 03	1730/-	1930/-



2	Code	Bright	Matt
	SANITROKING SQUARE FLAT CUT No. 4 SKSFC 04	1630/-	1830/-
	SANITROKING SQUARE FLAT CUT HINGE No. 4 SKSFCH 04	2130/-	2330/-

3	Code	Bright	Matt
	SANITROKING SQUARE GYPSY FLAT CUT No. 4 SKSGFC 04	1630/-	1830/-
	SANITROKING SQUARE GYPSY FLAT CUT HINGE No. 4 SKSGFCH 04	2130/-	2330/-

4	Code	Bright	Matt
	SANITROKING SQUARE FLAT CUT No. 5 SKSFC 05	2100/-	2300/-
	SANITROKING SQUARE FLAT CUT HINGE No. 5 SKSFCH 05	2600/-	2800/-

5	Code	Bright	Matt
	SANITROKING SQUARE GYPSY FLAT CUT No. 5 SKSGFC 05	2100/-	2300/-
	SANITROKING SQUARE GYPSY FLAT CUT HINGE No. 5 SKSGFCH 05	2600/-	2800/-

6	Code	Bright	Matt
	SANITROKING SQUARE DOUBLE GYPSY FLAT CUT No. 5 SKSDGFC 05	2100/-	2300/-
	SANITROKING SQUARE DOUBLE GYPSY FLAT CUT HINGE No. 5 SKSDGFCH 05	2600/-	2800/-

7	Code	Bright	Matt
	SANITROKING SQUARE CLASSIC FLAT CUT No. 5 SKSCFC 05	2600/-	2800/-
	SANITROKING SQUARE CLASSIC FLAT CUT HINGE No. 5 SKSCFCH 05	3100/-	3300/-

SANITROKING

SQUARE DOOM TYPE

HSN Code: 7326.90.30

Price 10 Pc. Per Box in INR

8	Code	Bright	Matt
	SANITROKING SQUARE FLAT CUT No. 6 SKSFCH 06	2750/-	2950/-
	SANITROKING SQUARE FLAT CUT HINGE NO. 6 SKSFCH 06	3250/-	3450/-

9	Code	Bright	Matt
	SANITROKING SQUARE GYPSY FLAT CUT NO. 6 SKSGFC 06	2750/-	2950/-
	SANITROKING SQUARE GYPSY FLAT CUT HINGE NO. 6 SKSGFCH 06	3250/-	3450/-

10	Code	Bright	Matt
	SANITROKING SQUARE DOUBLE GYPSY FLAT CUT No. 6 SKSDGFC 06	2750/-	2950/-
	SANITROKING SQUARE DOUBLE GYPSY FLAT CUT HINGE NO. 6 SKSDGFCH 06	3250/-	3450/-

11	Code	Bright	Matt
	SANITROKING SQUARE CLASSIC FLAT CUT NO. 6 SKSCFC 06	3250/-	3450/-
	SANITROKING SQUARE CLASSIC FLAT CUT HINGE NO. 6 SKSCFCH 06	3750/-	3950/-



SANITROKING

SQUARE FLAT TYPE

HSN Code: 7326.90.30

Price 10 Pc. Per Box in INR

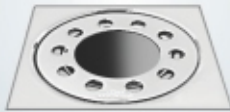

1	Code	Bright	Matt
	SANITROKING SQUARE FLAT TYPE FLAT CUT NO. 4 SKSFTFC 4x4	1630/-	1830/-
	SANITROKING SQUARE FLAT TYPE FLAT CUT NO. 4 HINGE SKSFTFCH 4x4	2130/-	2330/-
	SANITROKING SQUARE FLAT TYPE FLAT CUT NO. 4 SCREW SKSFTFCS 4x4	2130/-	2330/-
	SANITROKING SQUARE FLAT TYPE FLAT CUT NO. 4 LOCK SKSFTFCL 4x4	1830/-	2030/-

2	Code	Bright	Matt
	SANITROKING SQUARE GYPSY FLAT TYPE FLAT CUT NO. 4 SKSGFTFC 4x4	1630/-	1830/-
	SANITROKING SQUARE GYPSY FLAT TYPE FLAT CUT NO. 4 HINGE SKSGFTFCH 4x4	2130/-	2330/-
	SANITROKING SQUARE GYPSY FLAT TYPE FLAT CUT NO. 4 SCREW SKSGFTFCS 4x4	2130/-	2330/-
	SANITROKING SQUARE GYPSY FLAT TYPE FLAT CUT NO. 4 LOCK SKSGFTFCL 4x4	1830/-	2030/-

3	Code	Bright	Matt
	SANITROKING SQUARE CLASSIC FLAT TYPE FLAT CUT NO. 4 SKSCFTFC 4x4	1980/-	2180/-
	SANITROKING SQUARE CLASSIC FLAT TYPE FLAT CUT NO. 4 HINGE SKSCFTFCH 4x4	2480/-	2680/-
	SANITROKING SQUARE CLASSIC FLAT TYPE FLAT CUT NO. 4 SCREW SKSCFTFCS 4x4	2480/-	2680/-
	SANITROKING SQUARE CLASSIC FLAT TYPE FLAT CUT NO. 4 LOCK SKSCFTFCL 4x4	2180/-	2380/-

4	Code	Bright	Matt
	SANITROKING SQUARE RINGO FLAT TYPE FLAT CUT NO. 4 SKSRFTFC 4x4	1980/-	2180/-
	SANITROKING SQUARE RINGO FLAT TYPE FLAT CUT NO. 4 HINGE SKSRFTFCH 4x4	2480/-	2680/-
	SANITROKING SQUARE RINGO FLAT TYPE FLAT CUT NO. 4 SCREW SKSRFTFCS 4x4	2480/-	2680/-
	SANITROKING SQUARE RINGO FLAT TYPE FLAT CUT NO. 4 LOCK SKSRFTFCL 4x4	2180/-	2380/-

5	Code	Bright	Matt
	SANITROKING SQUARE FLAT TYPE FLAT CUT NO. 5 SKSFTFC 5x5	2100/-	2300/-
	SANITROKING SQUARE FLAT TYPE FLAT CUT HINGE NO. 5 SKSFTFCH 5x5	2600/-	2800/-
	SANITROKING SQUARE FLAT TYPE FLAT CUT SCREW NO. 5 SKSFTFCS 5x5	2600/-	2800/-
	SANITROKING SQUARE FLAT TYPE FLAT CUT LOCK NO. 5 SKSFTFCL 5x5	2300/-	2500/-

6	Code	Bright	Matt
	SANITROKING SQUARE GYPSY FLAT TYPE FLAT CUT NO. 5 SKSGFTFC 5x5	2100/-	2300/-
	SANITROKING SQUARE GYPSY FLAT TYPE FLAT CUT HINGE NO. 5 SKSGFTFCH 5x5	2600/-	2800/-
	SANITROKING SQUARE GYPSY FLAT TYPE FLAT CUT SCREW NO. 5 SKSGFTFCS 5x5	2600/-	2800/-
	SANITROKING SQUARE GYPSY FLAT TYPE FLAT CUT LOCK NO. 5 SKSGFTFCL 5x5	2300/-	2500/-

7	Code	Bright	Matt
	SANITROKING SQUARE GOLDEN CLASSIC FLAT TYPE FLAT CUT NO. 5 SKSGCFTFC 5x5	2820/-	3020/-
	SANITROKING SQUARE GOLDEN CLASSIC FLAT TYPE FLAT CUT NO. 5 HINGE SKSGCFTFCH 5x5	3320/-	3520/-
	SANITROKING SQUARE GOLDEN CLASSIC FLAT TYPE FLAT CUT NO. 5 SCREW SKSGCFTFCS 5x5	3320/-	3520/-
	SANITROKING SQUARE GOLDEN CLASSIC FLAT TYPE FLAT CUT NO. 5 LOCK SKSGCFTFCL 5x5	3020/-	3220/-

8	Code	Bright	Matt
	SANITROKING SQUARE GOLDEN CLASSIC GYPSY FLAT TYPE FLAT CUT NO. 5 SKSGCFTFC 5x5	2820/-	3020/-
	SANITROKING SQUARE GOLDEN CLASSIC GYPSY FLAT TYPE FLAT CUT NO. 5 HINGE SKSGCFTFCH 5x5	3320/-	3520/-
	SANITROKING SQUARE GOLDEN CLASSIC GYPSY FLAT TYPE FLAT CUT NO. 5 SCREW SKSGCFTFCS 5x5	3320/-	3520/-
	SANITROKING SQUARE GOLDEN CLASSIC GYPSY FLAT TYPE FLAT CUT NO. 5 LOCK SKSGCFTFCL 5x5	3020/-	3220/-

SANITROKING

SQUARE FLAT TYPE

HSN Code: 7326.90.30

Price 10 Pc. Per Box in INR

9	Code	Bright	Matt
	SANITROKING SQUARE RINGO FLAT TYPE FLAT CUT NO. 5 SKSRFTFC 5x5	2820/-	3020/-
	SANITROKING SQUARE RINGO FLAT TYPE FLAT CUT NO. 5 HINGE SKSRFTFCH 5x5	3320/-	3520/-
	SANITROKING SQUARE RINGO FLAT TYPE FLAT CUT NO. 5 SCREW SKSRFTFCS 5x5	3320/-	3520/-
	SANITROKING SQUARE RINGO FLAT TYPE FLAT CUT NO. 5 LOCK SKSRFTFCL 5x5	3020/-	3220/-

10	Code	Bright	Matt
	SANITROKING SQUARE RINGO GYPSY FLAT TYPE FLAT CUT NO. 5 SKSRGFTFC 5x5	2820/-	3020/-
	SANITROKING SQUARE RINGO GYPSY FLAT TYPE FLAT CUT NO. 5 HINGE SKSRGFTFCH 5x5	3320/-	3520/-
	SANITROKING SQUARE RINGO GYPSY FLAT TYPE FLAT CUT NO. 5 SCREW SKSRGFTFCS 5x5	3320/-	3520/-
	SANITROKING SQUARE RINGO GYPSY FLAT TYPE FLAT CUT NO. 5 LOCK SKSRGFTFCL 5x5	3020/-	3220/-

11	Code	Bright	Matt
	SANITROKING SQUARE EZEE FLAT TYPE FLAT CUT NO. 5 SKSEFTFC 5x5	2820/-	3020/-
	SANITROKING SQUARE EZEE FLAT TYPE FLAT CUT NO. 5 HINGE SKSEFTFCH 5x5	3320/-	3520/-
	SANITROKING SQUARE EZEE FLAT TYPE FLAT CUT NO. 5 SCREW SKSEFTFCS 5x5	3320/-	3520/-
	SANITROKING SQUARE EZEE FLAT TYPE FLAT CUT NO. 5 LOCK SKSEFTFCL 5x5	3020/-	3220/-

12	Code	Bright	Matt
	SANITROKING SQUARE EZEE GYPSY FLAT TYPE FLAT CUT NO. 5 SKSEGFTFC 5x5	2820/-	3020/-
	SANITROKING SQUARE EZEE GYPSY FLAT TYPE FLAT CUT NO. 5 HINGE SKSEGFTFCH 5x5	3320/-	3520/-
	SANITROKING SQUARE EZEE GYPSY FLAT TYPE FLAT CUT NO. 5 SCREW SKSEGFTFCS 5x5	3320/-	3520/-
	SANITROKING SQUARE EZEE GYPSY FLAT TYPE FLAT CUT NO. 5 LOCK SKSEGFTFCL 5x5	3020/-	3220/-

13	Code	Bright	Matt
	SANITROKING SQUARE FLAT TYPE FLAT CUT NO. 6 SKSFTFC 6x6	2750/-	2950/-
	SANITROKING SQUARE FLAT TYPE FLAT CUT NO. 6 HINGE SKSFTFCH 6x6	3250/-	3450/-
	SANITROKING SQUARE FLAT TYPE FLAT CUT NO. 6 SCREW SKSFTFCS 6x6	3250/-	3450/-
	SANITROKING SQUARE FLAT TYPE FLAT CUT NO. 6 LOCK SKSFTFCL 6x6	2950/-	3150/-

14	Code	Bright	Matt
	SANITROKING SQUARE GYPSY FLAT TYPE FLAT CUT NO. 6 SKSGFTFC 6x6	2750/-	2950/-
	SANITROKING SQUARE GYPSY FLAT TYPE FLAT CUT NO. 6 HINGE SKSGFTFCH 6x6	3250/-	3450/-
	SANITROKING SQUARE GYPSY FLAT TYPE FLAT CUT NO. 6 SCREW SKSGFTFCS 6x6	3250/-	3450/-
	SANITROKING SQUARE GYPSY FLAT TYPE FLAT CUT NO. 6 LOCK SKSGFTFCL 6x6	2950/-	3150/-

15	Code	Bright	Matt
	SANITROKING SQUARE GOLDEN CLASSIC FLAT TYPE FLAT CUT NO. 6 SKSGCFTFC 6x6	3500/-	3700/-
	SANITROKING SQUARE GOLDEN CLASSIC FLAT TYPE FLAT CUT NO. 6 HINGE SKSGCFTFCH 6x6	4000/-	4200/-
	SANITROKING SQUARE GOLDEN CLASSIC FLAT TYPE FLAT CUT NO. 6 SCREW SKSGCFTFCS 6x6	4000/-	4200/-
	SANITROKING SQUARE GOLDEN CLASSIC FLAT TYPE FLAT CUT NO. 6 LOCK SKSGCFTFCL 6x6	3700/-	3900/-

16	Code	Bright	Matt
	SANITROKING SQUARE GOLDEN CLASSIC GYPSY FLAT TYPE FLAT CUT NO. 6 SKSGCFTFC 6x6	3500/-	3700/-
	SANITROKING SQUARE GOLDEN CLASSIC GYPSY FLAT TYPE FLAT CUT NO. 6 HINGE SKSGCFTFCH 6x6	4000/-	4200/-
	SANITROKING SQUARE GOLDEN CLASSIC GYPSY FLAT TYPE FLAT CUT NO. 6 SCREW SKSGCFTFCS 6x6	4000/-	4200/-
	SANITROKING SQUARE GOLDEN CLASSIC GYPSY FLAT TYPE FLAT CUT NO. 6 LOCK SKSGCFTFCL 6x6	3700/-	3900/-

SANITROKING

SQUARE FLAT TYPE

HSN Code: 7326.90.30

Price 10 Pc. Per Box in INR

17	Code	Bright	Matt
	SANITROKING SQUARE RINGO FLAT TYPE FLAT CUT NO. 6 SKSRFTFC 6X6	3500/-	3700/-
	SANITROKING SQUARE RINGO FLAT TYPE FLAT CUT NO. 6 HINGE SKSRFTFCH 6X6	4000/-	4200/-
	SANITROKING SQUARE RINGO FLAT TYPE FLAT CUT NO. 6 SCREW SKSRFTFCS 6X6	4000/-	4200/-
	SANITROKING SQUARE RINGO FLAT TYPE FLAT CUT NO. 6 LOCK SKSRFTFCL 6X6	3700/-	3900/-

18	Code	Bright	Matt
	SANITROKING SQUARE RINGO GYPSY FLAT TYPE FLAT CUT NO. 6 SKSRGFTFC 6X6	3500/-	3700/-
	SANITROKING SQUARE RINGO GYPSY FLAT TYPE FLAT CUT NO. 6 HINGE SKSRGFTFCH 6X6	4000/-	4200/-
	SANITROKING SQUARE RINGO GYPSY FLAT TYPE FLAT CUT NO. 6 SCREW SKSRGFTFCS 6X6	4000/-	4200/-
	SANITROKING SQUARE RINGO GYPSY FLAT TYPE FLAT CUT NO. 6 LOCK SKSRGFTFCL 6X6	3700/-	3900/-

19	Code	Bright	Matt
	SANITROKING SQUARE EZEE FLAT TYPE FLAT CUT NO. 6 SKSEFTFC 6X6	3500/-	3700/-
	SANITROKING SQUARE EZEE FLAT TYPE FLAT CUT NO. 6 HINGE SKSEFTFCH 6X6	4000/-	4200/-
	SANITROKING SQUARE EZEE FLAT TYPE FLAT CUT NO. 6 SCREW SKSEFTFCS 6X6	4000/-	4200/-
	SANITROKING SQUARE EZEE FLAT TYPE FLAT CUT NO. 6 LOCK SKSEFTFCL 6X6	3700/-	3900/-

20	Code	Bright	Matt
	SANITROKING SQUARE EZEE GYPSY FLAT TYPE FLAT CUT NO. 6 SKSEGFTFC 6X6	3500/-	3700/-
	SANITROKING SQUARE EZEE GYPSY FLAT TYPE FLAT CUT NO. 6 HINGE SKSEGFTFCH 6X6	4000/-	4200/-
	SANITROKING SQUARE EZEE GYPSY FLAT TYPE FLAT CUT NO. 6 SCREW SKSEGFTFCS 6X6	4000/-	4200/-
	SANITROKING SQUARE EZEE GYPSY FLAT TYPE FLAT CUT NO. 6 LOCK SKSEGFTFCL 6X6	3700/-	3900/-

21	Code	Bright	Matt
	SANITROKING SQUARE FLAT TYPE FLAT CUT PLUS 140 SKSFTFCP 140 With Hidden Hinge	2600/-	2800/-

22	Code	Bright	Matt
	SANITROKING SQUARE GYPSY FLAT TYPE FLAT CUT PLUS 140 SKSGFTFCP 140 With Hidden Hinge	2600/-	2800/-

23	Code	Bright	Matt
	SANITROKING SQUARE FLAT TYPE PLUS 150 SKSFTFP 150 With Hidden Hinge	3250/-	3450/-

24	Code	Bright	Matt
	SANITROKING SQUARE GYPSY FLAT TYPE PLUS 150 SKSGFTFP 150 With Hidden Hinge	3250/-	3450/-

SANITROKING

ROUND DOOM TYPE

HSN Code: 7326.90.30

Price 10 Pc. Per Box in INR

1	Code	Bright	Matt
	SANITROKING ROUND NO. 3 SKR 03	1120/-	1320/-
	SANITROKING ROUND HINGE NO. 3 SKRH 03	1620/-	1820/-



2	Code	Bright	Matt
	SANITROKING ROUND NO. 4 SKR 04	1450/-	1650/-
	SANITROKING ROUND HINGE NO. 4 SKRH 04	1950/-	2150/-

3	Code	Bright	Matt
	SANITROKING ROUND GYPSY NO. 4 SKRG 04	1450/-	1650/-
	SANITROKING ROUND GYPSY HINGE NO. 4 SKRGH 04	1950/-	2150/-

4	Code	Bright	Matt
	SANITROKING ROUND NO. 5 SKR 05	1780/-	1980/-
	SANITROKING ROUND HINGE NO. 5 SKRH 05	2280/-	2480/-

5	Code	Bright	Matt
	SANITROKING ROUND GYPSY NO. 5 SKRG 05	1780/-	1980/-
	SANITROKING ROUND GYPSY HINGE NO. 5 SKRGH 05	2280/-	2480/-

6	Code	Bright	Matt
	SANITROKING ROUND DOUBLE GYPSY NO. 5 SKRDG 05	1780/-	1980/-
	SANITROKING ROUND DOUBLE GYPSY HINGE NO. 5 SKRDGH 05	2280/-	2480/-

7	Code	Bright	Matt
	SANITROKING ROUND CLASSIC NO. 5 SKRC 05	2320/-	2520/-
	SANITROKING ROUND CLASSIC HINGE NO. 5 SKRCH 05	2820/-	3020/-

SANITROKING

ROUND FLAT TYPE

HSN Code: 7326.90.30

Price 10 Pc. Per Box in INR



1	Code	Bright	Matt
	SANITROKING ROUND FLAT TYPE NO. 4 SKRFT 04	1450/-	1650/-
	SANITROKING ROUND FLAT TYPE HINGE NO. 4 SKRFTH 04	1950/-	2150/-
	SANITROKING ROUND FLAT TYPE SCREW NO. 4 SKRFTS 04	1950/-	2150/-
	SANITROKING ROUND FLAT TYPE LOCK NO. 4 SKRFTL 04	1650/-	1850/-

2	Code	Bright	Matt
	SANITROKING ROUND GYPSY FLAT TYPE NO. 4 SKRGFT 04	1450/-	1650/-
	SANITROKING ROUND GYPSY FLAT TYPE HINGE No. 4 SKRGFTH 04	1950/-	2150/-
	SANITROKING ROUND GYPSY FLAT TYPE SCREW No. 4 SKRGFTS 04	1950/-	2150/-
	SANITROKING ROUND GYPSY FLAT TYPE LOCK No. 4 SKRGFTL 04	1650/-	1850/-

3	Code	Bright	Matt
	SANITROKING ROUND GOLDEN CLASSIC FLAT TYPE NO. 4 SKRGCF 04	1650/-	1850/-
	SANITROKING ROUND GOLDEN CLASSIC FLAT TYPE HINGE NO. 4 SKRGCFH 04	2150/-	2350/-
	SANITROKING ROUND GOLDEN CLASSIC FLAT TYPE SCREW NO. 4 SKRGCF 04	2150/-	2350/-
	SANITROKING ROUND GOLDEN CLASSIC FLAT TYPE LOCK NO. 4 SKRGCF 04	1850/-	2050/-

4	Code	Bright	Matt
	SANITROKING ROUND RINGO FLAT TYPE NO. 4 SKRRFT 04	1650/-	1850/-
	SANITROKING ROUND RINGO FLAT TYPE HINGE NO. 4 SKRRFTH 04	2150/-	2350/-
	SANITROKING ROUND RINGO FLAT TYPE SCREW NO. 4 SKRRFTS 04	2150/-	2350/-
	SANITROKING ROUND RINGO FLAT TYPE LOCK NO. 4 SKRRFTL 04	1850/-	2050/-

5	Code	Bright	Matt
	SANITROKING ROUND FLAT TYPE NO. 5 SKRFT 05	1780/-	1980/-
	SANITROKING ROUND FLAT TYPE HINGE NO. 5 SKRFTH 05	2280/-	2480/-
	SANITROKING ROUND FLAT TYPE SCREW NO. 5 SKRFTS 05	2280/-	2480/-
	SANITROKING ROUND FLAT TYPE LOCK NO. 5 SKRFTL 05	1980/-	2180/-

6	Code	Bright	Matt
	SANITROKING ROUND GYPSY FLAT TYPE NO. 5 SKRGFT 05	1780/-	1980/-
	SANITROKING ROUND GYPSY FLAT TYPE HINGE NO. 5 SKRGFTH 05	2280/-	2480/-
	SANITROKING ROUND GYPSY FLAT TYPE SCREW NO. 5 SKRGFTS 05	2280/-	2480/-
	SANITROKING ROUND GYPSY FLAT TYPE LOCK NO. 5 SKRGFTL 05	1980/-	2180/-

SANITROKING

ROUND FLAT TYPE

HSN Code: 7326.90.30

Price 10 Pc. Per Box in INR

7	Code	Bright	Matt
	SANITROKING ROUND GOLDEN CLASSIC FLAT TYPE NO. 5 SKRGCFT 05	2620/-	2820/-
	SANITROKING ROUND GOLDEN CLASSIC FLAT TYPE HINGE NO. 5 SKRGCFTH 05	3120/-	3320/-
	SANITROKING ROUND GOLDEN CLASSIC FLAT TYPE SCREW NO. 5 SKRGCFTS 05	3120/-	3320/-
	SANITROKING ROUND GOLDEN CLASSIC FLAT TYPE LOCK NO. 5 SKRGCFTL 05	2820/-	3020/-

8	Code	Bright	Matt
	SANITROKING ROUND GOLDEN CLASSIC GYPSY FLAT TYPE NO. 5 SKRGCFT 05	2620/-	2820/-
	SANITROKING ROUND GOLDEN CLASSIC GYPSY FLAT TYPE HINGE NO. 5 SKRGCFTH 05	3120/-	3320/-
	SANITROKING ROUND GOLDEN CLASSIC GYPSY FLAT TYPE SCREW NO. 5 SKRGCFTS 05	3120/-	3320/-
	SANITROKING ROUND GOLDEN CLASSIC GYPSY FLAT TYPE LOCK NO. 5 SKRGCFTL 05	2820/-	3020/-

9	Code	Bright	Matt
	SANITROKING ROUND RINGO FLAT TYPE NO. 5 SKRRFT 05	2620/-	2820/-
	SANITROKING ROUND RINGO FLAT TYPE HINGE NO. 5 SKRRFTH 05	3120/-	3320/-
	SANITROKING ROUND RINGO FLAT TYPE SCREW NO. 5 SKRRFTS 05	3120/-	3320/-
	SANITROKING ROUND RINGO FLAT TYPE LOCK NO. 5 SKRRFTL 05	2820/-	3020/-

10	Code	Bright	Matt
	SANITROKING ROUND RINGO GYPSY FLAT TYPE NO. 5 SKRRGFT 05	2620/-	2820/-
	SANITROKING ROUND RINGO GYPSY FLAT TYPE HINGE NO. 5 SKRRGFTH 05	3120/-	3320/-
	SANITROKING ROUND RINGO GYPSY FLAT TYPE SCREW NO. 5 SKRRGFTS 05	3120/-	3320/-
	SANITROKING ROUND RINGO GYPSY FLAT TYPE LOCK NO. 5 SKRRGFTL 05	2820/-	3020/-

11	Code	Bright	Matt
	SANITROKING ROUND EEZE FLAT TYPE NO. 5 SKREFT 05	2620/-	2820/-
	SANITROKING ROUND EEZE FLAT TYPE HINGE NO. 5 SKREFTH 05	3120/-	3320/-
	SANITROKING ROUND EEZE FLAT TYPE SCREW NO. 5 SKREFTS 05	3120/-	3320/-
	SANITROKING ROUND EEZE FLAT TYPE LOCK NO. 5 SKREFTL 05	2820/-	3020/-

12	Code	Bright	Matt
	SANITROKING ROUND EEZE GYPSY FLAT TYPE NO. 5 SKREGFT 05	2620/-	2820/-
	SANITROKING ROUND EEZE GYPSY FLAT TYPE HINGE NO.5 SKREGFTH 05	3120/-	3320/-
	SANITROKING ROUND EEZE GYPSY FLAT TYPE SCREW NO.5 SKREGFTS 05	3120/-	3320/-
	SANITROKING ROUND EEZE GYPSY FLAT TYPE LOCK NO. 5 SKREGFTL 05	2820/-	3020/-

SANISQUARE

HSN Code: 7326.90.30

Price 10 Pc. Per Box in INR

1	Code	Bright	Matt
	SANISQUARE FLAT CUT SSFC 03	850/-	950/-

2	Code	Bright	Matt
	SANISQUARE FLAT CUT SSFC 04	1050/-	1150/-

3	Code	Bright	Matt
	SANISQUARE GYPSY FLAT CUT SSGFC 04	1050/-	1150/-

4	Code	Bright	Matt
	SANISQUARE CLASSIC FLAT CUT SSCFC 04	1150/-	1250/-

5	Code	Bright	Matt
	SANISQUARE FLAT CUT SSFC 05	1580/-	1680/-

6	Code	Bright	Matt
	SANISQUARE GYPSY FLAT CUT SSGFC 05	1580/-	1680/-

7	Code	Bright	Matt
	SANISQUARE DOUBLE GYPSY FLAT CUT SSDGFC 05	1580/-	1680/-

8	Code	Bright	Matt
	SANISQUARE CLASSIC FLAT CUT SSCFC 05	1680/-	1780/-

9	Code	Bright	Matt
	SANISQUARE FLAT CUT SSFC 06	1850/-	1950/-

10	Code	Bright	Matt
	SANISQUARE GYPSY FLAT CUT SSGFC 06	1850/-	1950/-

AMAZE SERIES

SQUARE

HSN Code: 7326.90.30

Price 10 Pc. Per Box in INR

1	Code	Bright	Matt
	AMAZE SQUARE FLAT CUT No.4 ASFC 04	1050/-	1150/-

2	Code	Bright	Matt
	AMAZE SQUARE GYPSY FLAT CUT No.4 ASGFC 04	1050/-	1150/-

3	Code	Bright	Matt
	AMAZE SQUARE FLAT CUT No.5 ASFC 05	1580/-	1680/-

4	Code	Bright	Matt
	AMAZE SQUARE GYPSY FLAT CUT No.5 ASGFC 05	1580/-	1680/-

5	Code	Bright	Matt
	AMAZE SQUARE FLAT CUT No.6 ASFC 06	1850/-	1950/-

6	Code	Bright	Matt
	AMAZE SQUARE GYPSY FLAT CUT No.6 ASGFC 06	1850/-	1950/-

PISTO SUPER

HSN Code: 7326.90.30

Price 10 Pc. Per Box in INR

1	Code	Bright	Matt	2	Code	Bright	Matt
	PISTO SUPER NO. 2 PS 02	350/-	450/-		PISTO SUPER NO. 3 PS 03	520/-	620/-
3	Code	Bright	Matt	4	Code	Bright	Matt
	PISTO SUPER GYPSY NO. 3 PSG 03	520/-	620/-		PISTO SUPER NO. 4 PS 04	690/-	790/-
5	Code	Bright	Matt	6	Code	Bright	Matt
	PISTO SUPER GYPSY NO. 4 PSG 04	690/-	790/-		PISTO SUPER NO. 5 PS 05	900/-	1000/-
7	Code	Bright	Matt	8	Code	Bright	Matt
	PISTO SUPER GYPSY NO. 5 PSG 05	900/-	1000/-		PISTO SUPER DOUBLE GYPSY NO. 5 PSDG 05	900/-	1000/-

PISTO SUPER

HSN Code: 7326.90.30

Price 10 Pc. Per Box in INR

9	Code	Bright	Matt	10	Code	Bright	Matt
	PISTO SUPER CLASSIC NO. 5 PSC 05	1400/-	1500/-		PISTO SUPER NO. 6 PS 06	1200/-	1300/-
	PISTO SUPER GYPSY NO. 6 PSG 06	1200/-	1300/-		PISTO SUPER DOUBLE GYPSY NO. 6 PSDG 06	1200/-	1300/-
	PISTO SUPER HEAVY NO. 6 PSH 06	1750/-	1850/-		PISTO SUPER GYPSY HEAVY NO. 6 PSGH 06	1750/-	1850/-

AMAZE SERIES

ROUND

HSN Code: 7326.90.30

Price 10 Pc. Per Box in INR

1	Code	Bright	Matt
	AMAZE ROUND NO. 4 AR 04	690/-	790/-

2	Code	Bright	Matt
	AMAZE ROUND GYPSY NO. 4 ARG 04	690/-	790/-

3	Code	Bright	Matt
	AMAZE ROUND NO. 5 AR 05	1200/-	1300/-

4	Code	Bright	Matt
	AMAZE ROUND GYPSY NO. 5 ARG 05	1200/-	1300/-

VERTICAL GRATING

HSN Code: 7326.90.30

Price 10 Pc. Per Box in INR

1	Code	Bright	Matt
	VERTICAL GRATING No. 2 VG 002	780/-	880/-

2	Code	Bright	Matt
	VERTICAL GRATING No. 3 VG 003	1420/-	1520/-

3	Code	Bright	Matt
	VERTICAL GRATING No. 4 VG 004	1950/-	2050/-

4	Code	Bright	Matt
	VERTICAL GRATING No. 5 VG 005	2500/-	2600/-

5	Code	Bright	Matt
	VERTICAL GRATING No. 6 VG 006	3200/-	3300/-

6	Code	Bright	Matt
	VERTICAL GRATING No. 8 VG 008	5300/-	5600/-

GOLDEN CLASSIC

HSN Code: 7326.90.30

Price 10 Pc. Per Box in INR

1	Code	Bright	Matt
	GOLDEN CLASSIC PLAIN No. 2 GCP 02	600/-	700/-

2	Code	Bright	Matt
	GOLDEN CLASSIC PLAIN No. 3 GCP 03	1100/-	1200/-

3	Code	Bright	Matt
	GOLDEN CLASSIC PLAIN No. 4 GCP 04	1600/-	1700/-

4	Code	Bright	Matt
	GOLDEN CLASSIC GYPSY No. 4 GCG 04	1600/-	1700/-

5	Code	Bright	Matt
	GOLDEN CLASSIC PLAIN No. 5 GCP 05	2100/-	2200/-

6	Code	Bright	Matt
	GOLDEN CLASSIC GYPSY No. 5 GCG 05	2100/-	2200/-

THREE 'O' FOUR (SS 304)

SQUARE

HSN Code: 7326.90.30

AISI 304 (18/8) Stainless Steel

Price Per Pc. in INR



1	Code	Bright	Matt
	TOF-SFC-76 Square Flat Cut	300/-	350/-
	TOF-SFCH-76 Square Flat Cut Hinge	400/-	450/-
	TOF-SFCS-76 Square Flat Cut Screw	400/-	450/-

2	Code	Bright	Matt
	TOF-SGFC-76 Square Gypsy Flat Cut	300/-	350/-
	TOF-SGFCH-76 Square Gypsy Flat Cut Hinge	400/-	450/-
	TOF-SGFCS-76 Square Gypsy Flat Cut Screw	400/-	450/-

3	Code	Bright	Matt
	TOF-SRFC-76 Square Ringo Flat Cut	350/-	400/-
	TOF-SRFCH-76 Square Ringo Flat Cut Hinge	450/-	500/-
	TOF-SRFCS-76 Square Ringo Flat Cut Screw	450/-	500/-

4	Code	Bright	Matt
	TOF-SFC-101 Square Flat Cut	360/-	460/-
	TOF-SFCH-101 Square Flat Cut Hinge	460/-	560/-
	TOF-SFCS-101 Square Flat Cut Screw	460/-	560/-
	TOF-SFCL-101 Square Flat Cut Lock	410/-	510/-

5	Code	Bright	Matt
	TOF-SGFC-101 Square Gypsy Flat Cut	360/-	460/-
	TOF-SGFCH-101 Square Gypsy Flat Cut Hinge	460/-	560/-
	TOF-SGFCS-101 Square Gypsy Flat Cut Screw	460/-	560/-
	TOF-SGFCL-101 Square Gypsy Flat Cut Lock	410/-	510/-

6	Code	Bright	Matt
	TOF-SCFC-101 Square Classic Flat Cut	410/-	510/-
	TOF-SCFCH-101 Square Classic Flat Cut Hinge	510/-	610/-
	TOF-SCFCS-101 Square Classic Flat Cut Screw	510/-	610/-
	TOF-SCFCL-101 Square Classic Flat Cut Lock	460/-	560/-

7	Code	Bright	Matt
	TOF-SRFC-101 Square Ringo Flat Cut	410/-	510/-
	TOF-SRFCH-101 Square Ringo Flat Cut Hinge	510/-	610/-
	TOF-SRFCS-101 Square Ringo Flat Cut Screw	510/-	610/-
	TOF-SRFCL-101 Square Ringo Flat Cut Lock	460/-	560/-

THREE 'O' FOUR (SS 304)

SQUARE

HSN Code: 7326.90.30

AINI 304 (18/8) Stainless Steel

Price Per Pc. in INR

8	Code	Bright	Matt
	TOF-SFC-127 Square Flat Cut	410/-	510/-
	TOF-SFCH-127 Square Flat Cut Hinge	510/-	610/-
	TOF-SFCS-127 Square Flat Cut Screw	510/-	610/-
	TOF-SFCL-127 Square Flat Cut Lock	460/-	560/-

9	Code	Bright	Matt
	TOF-SGFC-127 Square Gypsy Flat Cut	410/-	510/-
	TOF-SGFCH-127 Square Gypsy Flat Cut Hinge	510/-	610/-
	TOF-SGFCS-127 Square Gypsy Flat Cut Screw	510/-	610/-
	TOF-SGFCL-127 Square Gypsy Flat Cut Lock	460/-	560/-

10	Code	Bright	Matt
	TOF-SCFC-127 Square Classic Flat Cut	510/-	610/-
	TOF-SCFCH-127 Square Classic Flat Cut Hinge	610/-	710/-
	TOF-SCFCS-127 Square Classic Flat Cut Screw	610/-	710/-
	TOF-SCFCL-127 Square Classic Flat Cut Lock	560/-	660/-

11	Code	Bright	Matt
	TOF-SCGFC-127 Square Classic Gypsy Flat Cut	510/-	610/-
	TOF-SCGFCH-127 Square Classic Gypsy Flat Cut Hinge	610/-	710/-
	TOF-SCGFCS-127 Square Classic Gypsy Flat Cut Screw	610/-	710/-
	TOF-SCGFCL-127 Square Classic Gypsy Flat Cut Lock	560/-	660/-

12	Code	Bright	Matt
	TOF-SRFC-127 Square Ringo Flat Cut	510/-	610/-
	TOF-SRFCH-127 Square Ringo Flat Cut Hinge	610/-	710/-
	TOF-SRFCS-127 Square Ringo Flat Cut Screw	610/-	710/-
	TOF-SRFCL-127 Square Ringo Flat Cut Lock	560/-	660/-

13	Code	Bright	Matt
	TOF-SRGFC-127 Square Ringo Gypsy Flat Cut	510/-	610/-
	TOF-SRGFCH-127 Square Ringo Gypsy Flat Cut Hinge	610/-	710/-
	TOF-SRGFCS-127 Square Ringo Gypsy Flat Cut Screw	610/-	710/-
	TOF-SRGFCL-127 Square Ringo Gypsy Flat Cut Lock	560/-	660/-

14	Code	Bright	Matt
	TOF-SEFC-127 Square Ezee Flat Cut	510/-	610/-
	TOF-SEFCH-127 Square Ezee Flat Cut Hinge	610/-	710/-
	TOF-SEFCS-127 Square Ezee Flat Cut Screw	610/-	710/-
	TOF-SEFCL-127 Square Ezee Flat Cut Lock	560/-	660/-

15	Code	Bright	Matt
	TOF-SEGFC-127 Square Ezee Gypsy Flat Cut	510/-	610/-
	TOF-SEGFCH-127 Square Ezee Gypsy Flat Cut Hinge	610/-	710/-
	TOF-SEGFCS-127 Square Ezee Gypsy Flat Cut Screw	610/-	710/-
	TOF-SEGFCL-127 Square Ezee Gypsy Flat Cut Lock	560/-	660/-

THREE 'O' FOUR (SS 304)

SQUARE

HSN Code: 7326.90.30

AISI 304 (18/8) Stainless Steel

Price Per Pc. in INR

16	Code	Bright	Matt
	TOF-SFC-153 Square Flat Cut	510/-	610/-
	TOF-SFCH-153 Square Flat Cut Hinge	610/-	710/-
	TOF-SFCS-153 Square Flat Cut Screw	610/-	710/-
	TOF-SFCL-153 Square Flat Cut Lock	560/-	660/-

17	Code	Bright	Matt
	TOF-SGFC-153 Square Gypsy Flat Cut	510/-	610/-
	TOF-SGFCH-153 Square Gypsy Flat Cut Hinge	610/-	710/-
	TOF-SGFCS-153 Square Gypsy Flat Cut Screw	610/-	710/-
	TOF-SGFCL-153 Square Gypsy Flat Cut Lock	560/-	660/-

18	Code	Bright	Matt
	TOF-SCFC-153 Square Classic Flat Cut	610/-	710/-
	TOF-SCFCH-153 Square Classic Flat Cut Hinge	710/-	810/-
	TOF-SCFCS-153 Square Classic Flat Cut Screw	710/-	810/-
	TOF-SCFCL-153 Square Classic Flat Cut Lock	660/-	760/-

19	Code	Bright	Matt
	TOF-SCGFC-153 Square Classic Gypsy Flat Cut	610/-	710/-
	TOF-SCGFCH-153 Square Classic Gypsy Flat Cut Hinge	710/-	810/-
	TOF-SCGFCS-153 Square Classic Gypsy Flat Cut Screw	710/-	810/-
	TOF-SCGFCL-153 Square Classic Gypsy Flat Cut Lock	660/-	760/-

20	Code	Bright	Matt
	TOF-SRFC-153 Square Ringo Flat Cut	610/-	710/-
	TOF-SRFCH-153 Square Ringo Flat Cut Hinge	710/-	810/-
	TOF-SRFCS-153 Square Ringo Flat Cut Screw	710/-	810/-
	TOF-SRFCL-153 Square Ringo Flat Cut Lock	660/-	760/-

21	Code	Bright	Matt
	TOF-SRGFC-153 Square Ringo Gypsy Flat Cut	610/-	710/-
	TOF-SRGFCH-153 Square Ringo Gypsy Flat Cut Hinge	710/-	810/-
	TOF-SRGFCS-153 Square Ringo Gypsy Flat Cut Screw	710/-	810/-
	TOF-SRGFCL-153 Square Ringo Gypsy Flat Cut Lock	660/-	760/-

22	Code	Bright	Matt
	TOF-SEFC-153 Square Ezee Flat Cut	610/-	710/-
	TOF-SEFCH-153 Square Ezee Flat Cut Hinge	710/-	810/-
	TOF-SEFCS-153 Square Ezee Flat Cut Screw	710/-	810/-
	TOF-SEFCL-153 Square Ezee Flat Cut Lock	660/-	760/-

23	Code	Bright	Matt
	TOF-SEGFC-153 Square Ezee Gypsy Flat Cut	610/-	710/-
	TOF-SEGFCH-153 Square Ezee Gypsy Flat Cut Hinge	710/-	810/-
	TOF-SEGFCS-153 Square Ezee Gypsy Flat Cut Screw	710/-	810/-
	TOF-SEGFCL-153 Square Ezee Gypsy Flat Cut Lock	660/-	760/-

THREE 'O' FOUR (SS 304)

SQUARE

HSN Code: 7326.90.30

AISI 304 (18/8) Stainless Steel

Price Per Pc. in INR

24	Code	Bright	Matt
	TOF-SFC-200 Square Flat Cut	2600/-	2800/-
	TOF-SFCH-200 Square Flat Cut Hinge	2700/-	2900/-
	TOF-SFCS-200 Square Flat Cut Screw	2700/-	2900/-

25	Code	Bright	Matt
	TOF-SGFC-200 Square Gypsy Flat Cut	2600/-	2800/-
	TOF-SGFCH-200 Square Gypsy Flat Cut Hinge	2700/-	2900/-
	TOF-SGFCS-200 Square Gypsy Flat Cut Screw	2700/-	2900/-

26	Code	Bright	Matt
	TOF-SFC-255 Square Flat Cut	3900/-	4100/-
	TOF-SFCH-255 Square Flat Cut Hinge	4000/-	4200/-
	TOF-SFCS-255 Square Flat Cut Screw	4000/-	4200/-

27	Code	Bright	Matt
	TOF-SGFC-255 Square Gypsy Flat Cut	3900/-	4100/-
	TOF-SGFCH-255 Square Gypsy Flat Cut Hinge	4000/-	4200/-
	TOF-SGFCS-255 Square Gypsy Flat Cut Screw	4000/-	4200/-

28	Code	Bright	Matt
	TOF-SFC-300 Square Flat Cut	5500/-	5700/-
	TOF-SFCH-300 Square Flat Cut Hinge	5600/-	5800/-
	TOF-SFCS-300 Square Flat Cut Screw	5600/-	5800/-

29	Code	Bright	Matt
	TOF-SGFC-300 Square Gypsy Flat Cut	5500/-	5700/-
	TOF-SGFCH-300 Square Gypsy Flat Cut Hinge	5600/-	5800/-
	TOF-SGFCS-300 Square Gypsy Flat Cut Screw	5600/-	5800/-

THREE 'O' FOUR (SS 304)

SQUARE GOLDEN SERIES

HSN Code: 7326.90.30

AISI 304 (18/8) Stainless Steel

Price Per Pc. in INR

1	Code	Bright	Matt
	TOF-SFC-GS-127 Square Flat Cut Golden Series	550/-	650/-
	TOF-SFCH-GS-127 Square Flat Cut Golden Series Hinge	650/-	750/-
	TOF-SFCS-GS-127 Square Flat Cut Golden Series Screw	650/-	750/-

2	Code	Bright	Matt
	TOF-SGFC-GS-127 Square Gypsy Flat Cut Golden Series	550/-	650/-
	TOF-SGFCH-GS-127 Square Gypsy Flat Cut Golden Series Hinge	650/-	750/-
	TOF-SGFCS-GS-127 Square Flat Cut Golden Series Screw	650/-	750/-

3	Code	Bright	Matt
	TOF-SCFC-GS-127 Square Classic Flat Cut Golden Series	550/-	650/-
	TOF-SCFCH-GS-127 Square Classic Flat Cut Golden Series Hinge	650/-	750/-
	TOF-SCFCS-GS-127 Square Classic Flat Cut Golden Series Screw	650/-	750/-

4	Code	Bright	Matt
	TOF-SCGFC-GS-127 Square Classic Gypsy Flat Cut Golden Series	550/-	650/-
	TOF-SCGFCH-GS-127 Square Classic Gypsy Flat Cut Golden Series Hinge	650/-	750/-
	TOF-SCGFCS-GS-127 Square Classic Gypsy Flat Cut Golden Series Screw	650/-	750/-

5	Code	Bright	Matt
	TOF-SEFC-GS-127 Square Ezee Flat Cut Golden Series	550/-	650/-
	TOF-SEFCH-GS-127 Square Ezee Flat Cut Golden Series Hinge	650/-	750/-
	TOF-SEFCS-GS-127 Square Ezee Flat Cut Golden Series Screw	650/-	750/-

6	Code	Bright	Matt
	TOF-SEGFC-GS-127 Square Ezee Gypsy Flat Cut Golden Series	550/-	650/-
	TOF-SEGFCH-GS-127 Square Ezee Gypsy Flat Cut Golden Series Hinge	650/-	750/-
	TOF-SEGFCS-GS-127 Square Ezee Gypsy Flat Cut Golden Series Screw	650/-	750/-

7	Code	Bright	Matt
	TOF-SVFC-GS-127 Square Vertical Flat Cut Golden Series	550/-	650/-
	TOF-SVFCH-GS-127 Square Vertical Flat Cut Golden Series Hinge	650/-	750/-
	TOF-SVFCS-GS-127 Square Vertical Flat Cut Golden Series Screw	650/-	750/-

8	Code	Bright	Matt
	TOF-SVGFC-GS-127 Square Vertical Gypsy Flat Cut Golden Series	550/-	650/-
	TOF-SVGFCH-GS-127 Square Vertical Gypsy Flat Cut Golden Series Hinge	650/-	750/-
	TOF-SVGFCS-GS-127 Square Vertical Gypsy Flat Cut Golden Series Screw	650/-	750/-

THREE 'O' FOUR (SS 304)

SQUARE GOLDEN SERIES

HSN Code: 7326.90.30

AISI 304 (18/8) Stainless Steel

Price Per Pc. in INR

9	Code	Bright	Matt
	TOF-SZFC-GS-127 Square Zoom Flat Cut Golden Series	550/-	650/-
	TOF-SZFCH-GS-127 Square Zoom Flat Cut Golden Series Hinge	650/-	750/-
	TOF-SZFCS-GS-127 Square Zoom Flat Cut Golden Series Screw	650/-	750/-

10	Code	Bright	Matt
	TOF-SZGFC-GS-127 Square Zoom Gypsy Flat Cut Golden Series	550/-	650/-
	TOF-SZGFCH-GS-127 Square Zoom Gypsy Flat Cut Golden Series Hinge	650/-	750/-
	TOF-SZGFCS-GS-127 Square Zoom Gypsy Flat Cut Golden Series Screw	650/-	750/-

11	Code	Bright	Matt
	TOF-SMFC-GS-127 Square Maze Flat Cut Golden Series	550/-	650/-
	TOF-SMFCH-GS-127 Square Maze Flat Cut Golden Series Hinge	650/-	750/-
	TOF-SMFCS-GS-127 Square Maze Flat Cut Golden Series Screw	650/-	750/-

12	Code	Bright	Matt
	TOF-SMGFC-GS-127 Square Maze Gypsy Flat Cut Golden Series	550/-	650/-
	TOF-SMGFCH-GS-127 Square Maze Gypsy Flat Cut Golden Series Hinge	650/-	750/-
	TOF-SMGFCS-GS-127 Square Maze Gypsy Flat Cut Golden Series Screw	650/-	750/-

13	Code	Bright	Matt
	TOF-SRFC-GS-127 Square Ringo Flat Cut Golden Series	550/-	650/-
	TOF-SRFCH-GS-127 Square Ringo Flat Cut Golden Series Hinge	650/-	750/-
	TOF-SRFCS-GS-127 Square Ringo Flat Cut Golden Series Screw	650/-	750/-

14	Code	Bright	Matt
	TOF-SRGFC-GS-127 Square Ringo Gypsy Flat Cut Golden Series	550/-	650/-
	TOF-SRGFCH-GS-127 Square Ringo Gypsy Flat Cut Golden Series Hinge	650/-	750/-
	TOF-SRGFCS-GS-127 Square Ringo Gypsy Flat Cut Golden Series Screw	650/-	750/-

15	Code	Bright	Matt
	TOF-SCLFC-GS-127 Square Clean Line Flat Cut Golden Series	550/-	650/-
	TOF-SCLFCH-GS-127 Square Clean Line Flat Cut Hinge Golden Series	650/-	750/-
	TOF-SCLFCS-GS-127 Square Clean Line Flat Cut Screw Golden Series	650/-	750/-

16	Code	Bright	Matt
	TOF-SCLGFC-GS-127 Square Clean Line Gypsy Flat Cut Golden Series	550/-	650/-
	TOF-SCLGFCH-GS-127 Square Clean Line Gypsy Flat Cut Hinge Golden Series	650/-	750/-
	TOF-SCLGFCS-GS-127 Square Clean Line Gypsy Flat Cut Screw Golden Series	650/-	750/-

THREE 'O' FOUR (SS 304)

SQUARE GOLDEN SERIES

HSN Code: 7326.90.30

AISI 304 (18/8) Stainless Steel

Price Per Pc. in INR

17	Code	Bright	Matt
	TOF-SFC-GS-153 Square Flat Cut Golden Series	650/-	750/-
	TOF-SFCH-GS-153 Square Flat Cut Golden Series Hinge	750/-	850/-
	TOF-SFCS-GS-153 Square Flat Cut Golden Series Screw	750/-	850/-

18	Code	Bright	Matt
	TOF-SGFC-GS-153 Square Gypsy Flat Cut Golden Series	650/-	750/-
	TOF-SGFCH-GS-153 Square Gypsy Flat Cut Golden Series Hinge	750/-	850/-
	TOF-SGFCS-GS-153 Square Gypsy Flat Cut Golden Series Screw	750/-	850/-

19	Code	Bright	Matt
	TOF-SCFC-GS-153 Square Classic Flat Cut Golden Series	650/-	750/-
	TOF-SCFCH-GS-153 Square Classic Flat Cut Golden Series Hinge	750/-	850/-
	TOF-SCFCS-GS-153 Square Classic Flat Cut Golden Series Screw	750/-	850/-

20	Code	Bright	Matt
	TOF-SCGFC-GS-153 Square Classic Gypsy Flat Cut Golden Series	650/-	750/-
	TOF-SCGFCH-GS-153 Square Classic Gypsy Flat Cut Golden Series Hinge	750/-	850/-
	TOF-SCGFCS-GS-153 Square Classic Gypsy Flat Cut Golden Series Screw	750/-	850/-

21	Code	Bright	Matt
	TOF-SEFC-GS-153 Square Ezee Flat Cut Golden Series	650/-	750/-
	TOF-SEFCH-GS-153 Square Ezee Flat Cut Golden Series Hinge	750/-	850/-
	TOF-SEFCS-GS-153 Square Ezee Flat Cut Golden Series Screw	750/-	850/-

22	Code	Bright	Matt
	TOF-SEGFC-GS-153 Square Ezee Gypsy Flat Cut Golden Series	650/-	750/-
	TOF-SEGFCH-GS-153 Square Ezee Gypsy Flat Cut Golden Series Hinge	750/-	850/-
	TOF-SEGFCS-GS-153 Square Ezee Gypsy Flat Cut Golden Series Screw	750/-	850/-

23	Code	Bright	Matt
	TOF-SVFC-GS-153 Square Vertical Flat Cut Golden Series	650/-	750/-
	TOF-SVFCH-GS-153 Square Vertical Flat Cut Golden Series Hinge	750/-	850/-
	TOF-SVFCS-GS-153 Square Vertical Flat Cut Golden Series Screw	750/-	850/-

24	Code	Bright	Matt
	TOF-SVGFC-GS-153 Square Gypsy Flat Cut Golden Series	650/-	750/-
	TOF-SVGFCH-GS-153 Square Gypsy Flat Cut Golden Series Hinge	750/-	850/-
	TOF-SVGFCS-GS-153 Square Gypsy Flat Cut Golden Series Screw	750/-	850/-

THREE 'O' FOUR (SS 304)

SQUARE GOLDEN SERIES

HSN Code: 7326.90.30

AISI 304 (18/8) Stainless Steel

Price Per Pc. in INR

25	Code	Bright	Matt
	TDF-SZFC-GS-153 Square Zoom Flat Cut Golden Series	650/-	750/-
	TDF-SZFCH-GS-153 Square Zoom Flat Cut Golden Series Hinge	750/-	850/-
	TDF-SZFCS-GS-153 Square Zoom Flat Cut Golden Series Screw	750/-	850/-

26	Code	Bright	Matt
	TDF-SZGFC-GS-153 Square Zoom Gypsy Flat Cut Golden Series	650/-	750/-
	TDF-SZGFCH-GS-153 Square Zoom Gypsy Flat Cut Golden Series Hinge	750/-	850/-
	TDF-SZGFCS-GS-153 Square Zoom Gypsy Flat Cut Golden Series Screw	750/-	850/-

27	Code	Bright	Matt
	TDF-SMFCH-GS-153 Square Maze Flat Cut Golden Series Gypsy	650/-	750/-
	TDF-SMFCH-GS-153 Square Maze Flat Cut Golden Series Hinge Gypsy	750/-	850/-
	TDF-SMFCS-GS-153 Square Maze Flat Cut Golden Series Screw Gypsy	750/-	850/-

28	Code	Bright	Matt
	TDF-SMGFC-GS-153 Square Maze Gypsy Flat Cut Golden Series	650/-	750/-
	TDF-SMGFCH-GS-153 Square Maze Gypsy Flat Cut Golden Series Hinge	750/-	850/-
	TDF-SMGFCS-GS-153 Square Maze Gypsy Flat Cut Golden Series Screw	750/-	850/-

29	Code	Bright	Matt
	TDF-SRFC-GS-153 Square Ringo Flat Cut Golden Series	650/-	750/-
	TDF-SRFCH-GS-153 Square Ringo Flat Cut Golden Series Hinge	750/-	850/-
	TDF-SRFCS-GS-153 Square Ringo Flat Cut Golden Series Screw	750/-	850/-

30	Code	Bright	Matt
	TDF-SRGFC-GS-153 Square Ringo Gypsy Flat Cut Golden Series	650/-	750/-
	TDF-SRGFCH-GS-153 Square Ringo Gypsy Flat Cut Golden Series Hinge	750/-	850/-
	TDF-SRGFCS-GS-153 Square Ringo Gypsy Flat Cut Golden Series Screw	750/-	850/-

31	Code	Bright	Matt
	TDF-SCLFC-GS-153 Square Clean Line Flat Cut Golden Series	650/-	750/-
	TDF-SCLFCH-GS-153 Square Clean Line Flat Cut Golden Series Hinge	750/-	850/-
	TDF-SCLFCS-GS-153 Square Clean Line Flat Cut Golden Series Screw	750/-	850/-

32	Code	Bright	Matt
	TDF-SCLGFC-GS-153 Square Clean Line Gypsy Flat Cut Golden Series	650/-	750/-
	TDF-SCLGFCH-GS-153 Square Clean Line Gypsy Flat Cut Golden Series Hinge	750/-	850/-
	TDF-SCLGFCS-GS-153 Square Clean Line Gypsy Flat Cut Golden Series Screw	750/-	850/-

THREE 'O' FOUR (SS 304)

ROUND

HSN Code: 7326.90.30

AISI 304 (18/8) Stainless Steel

Price Per Pc. in INR



1	Code	Bright	Matt
	TOF-R-80 Round	200/-	250/-
	TOF-RH-80 Round Hinge	250/-	300/-
	TOF-RS-80 Round Screw	250/-	300/-

2	Code	Bright	Matt
	TOF-RG-80 Round Gypsy	200/-	250/-
	TOF-RGH-80 Round Gypsy Hinge	250/-	300/-
	TOF-RGS-80 Round Gypsy Screw	250/-	300/-

3	Code	Bright	Matt
	TOF-RR-80 Round Ringo	250/-	300/-
	TOF-RRH-80 Round Ringo Hinge	350/-	400/-
	TOF-RRS-80 Round Ringo Screw	350/-	400/-

4	Code	Bright	Matt
	TOF-R-101 Round	260/-	360/-
	TOF-RH-101 Round Hinge	360/-	460/-
	TOF-RS-101 Round Screw	360/-	460/-
	TOF-RL-101 Round Lock	310/-	410/-

5	Code	Bright	Matt
	TOF-RG-101 Round Gypsy	260/-	360/-
	TOF-RGH-101 Round Gypsy Hinge	360/-	460/-
	TOF-RGS-101 Round Gypsy Screw	360/-	460/-
	TOF-RGL-101 Round Gypsy Lock	310/-	410/-

6	Code	Bright	Matt
	TOF-RC-101 Round Classic	310/-	410/-
	TOF-RCH-101 Round Classic Hinge	410/-	510/-
	TOF-RCS-101 Round Classic Screw	410/-	510/-
	TOF-RCL-101 Round Classic Lock	360/-	460/-

7	Code	Bright	Matt
	TOF-RR-101 Round Ringo	310/-	410/-
	TOF-RRH-101 Round Ringo Hinge	410/-	510/-
	TOF-RRS-101 Round Ringo Screw	410/-	510/-
	TOF-RRL-101 Round Ringo Lock	360/-	460/-

THREE 'O' FOUR (SS 304)

ROUND

HSN Code: 7326.90.30

AISI 304 (18/8) Stainless Steel

Price Per Pc. in INR

8	Code	Bright	Matt
	TOF-R-127 Round	310/-	410/-
	TOF-RH-127 Round Hinge	410/-	510/-
	TOF-RS-127 Round Screw	410/-	510/-
	TOF-RL-127 Round Lock	360/-	460/-

9	Code	Bright	Matt
	TOF-RG-127 Round Gypsy	310/-	410/-
	TOF-RGH-127 Round Gypsy Hinge	410/-	510/-
	TOF-RGS-127 Round Gypsy Screw	410/-	510/-
	TOF-RGL-127 Round Gypsy Lock	360/-	460/-

10	Code	Bright	Matt
	TOF-RC-127 Round Classic	410/-	510/-
	TOF-RCH-127 Round Classic Hinge	510/-	610/-
	TOF-RCS-127 Round Classic Screw	510/-	610/-
	TOF-RCL-127 Round Classic Lock	460/-	560/-

11	Code	Bright	Matt
	TOF-RCG-127 Round Classic Gypsy	410/-	510/-
	TOF-RCGH-127 Round Classic Gypsy Hinge	510/-	610/-
	TOF-RCGS-127 Round Classic Gypsy Screw	510/-	610/-
	TOF-RCGL-127 Round Classic Gypsy Lock	460/-	560/-

12	Code	Bright	Matt
	TOF-RR-127 Round Ringo	410/-	510/-
	TOF-RRH-127 Round Ringo Hinge	510/-	610/-
	TOF-RRS-127 Round Ringo Screw	510/-	610/-
	TOF-RRL-127 Round Ringo Lock	460/-	560/-

13	Code	Bright	Matt
	TOF-RRG-127 Round Ringo Gypsy	410/-	510/-
	TOF-RRGH-127 Round Ringo Gypsy Hinge	510/-	610/-
	TOF-RRGS-127 Round Ringo Gypsy Screw	510/-	610/-
	TOF-RRGL-127 Round Ringo Gypsy Lock	460/-	560/-

14	Code	Bright	Matt
	TOF-RE-127 Round Ezee	410/-	510/-
	TOF-REH-127 Round Ezee Hinge	510/-	610/-
	TOF-RES-127 Round Ezee Screw	510/-	610/-
	TOF-REL-127 Round Ezee Lock	460/-	560/-

15	Code	Bright	Matt
	TOF-REG-127 Round Ezee Gypsy	410/-	510/-
	TOF-REGH-127 Round Ezee Gypsy Hinge	510/-	610/-
	TOF-REGS-127 Round Ezee Gypsy Screw	510/-	610/-
	TOF-REGL-127 Round Ezee Gypsy Lock	460/-	560/-

THREE 'O' FOUR (SS 304)

ROUND

HSN Code: 7326.90.30

AISI 304 (18/8) Stainless Steel

Price Per Pc. in INR

16	Code	Bright	Matt
	TOF-RFC-205 Round Flat Cut	2200/-	2300/-
	TOF-RFCH-205 Round Flat Cut Hinge	2300/-	2400/-
	TOF-RFCS-205 Round Flat Cut Screw	2300/-	2400/-

17	Code	Bright	Matt
	TOF-RGFC-205 Round Gypsy Flat Cut	2200/-	2300/-
	TOF-RGFCH-205 Round Gypsy Flat Cut Hinge	2300/-	2400/-
	TOF-RGFCS-205 Round Gypsy Flat Cut Screw	2300/-	2400/-

RAIL DRAINER SQUARE

HSN Code: 7326.90.30

Price Per Pc. in INR



WITH FRAME

200mm x 200mm
250mm x 250mm
300mm x 300mm

RAIL DRAINER SQUARE

200mm x 200mm
250mm x 250mm
300mm x 300mm

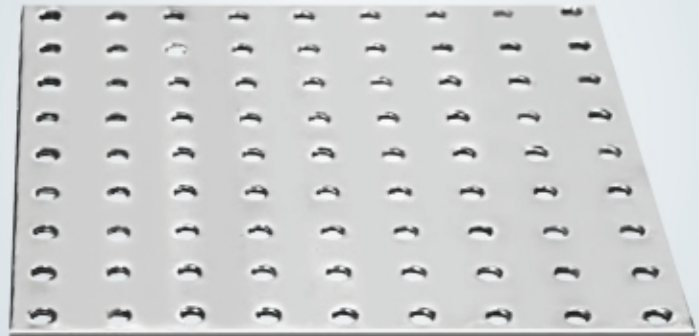

FAST DISPOSAL

S.No.	MODEL CODE & NAME	SIZE PIPE DIA.	No.	RATE PCS. BOX IN Rs.	
				BRIGHT	MATT
1.	RAIL DRAINER SQUARE WITH FRAME (200mm x 200mm)	150mm (6")	8	5600/-	6000/-
2.	RAIL DRAINER SQUARE WITH FRAME (250mm x 250mm)	200mm (8")	10	7000/-	7400/-
3.	RAIL DRAINER SQUARE WITH FRAME (300mm x 300mm)	250mm (10")	12	9000/-	9500/-
4.	RAIL DRAINER SQUARE (200mm x 200mm)	150mm (6")	8	2200/-	2800/-
5.	RAIL DRAINER SQUARE (250mm x 250mm)	200mm (8")	10	2800/-	3200/-
6.	RAIL DRAINER SQUARE (300mm x 300mm)	250mm (10")	12	3500/-	4000/-

RAIL DRAINER

HSN Code: 7326.90.30

Price Per Pc. in INR

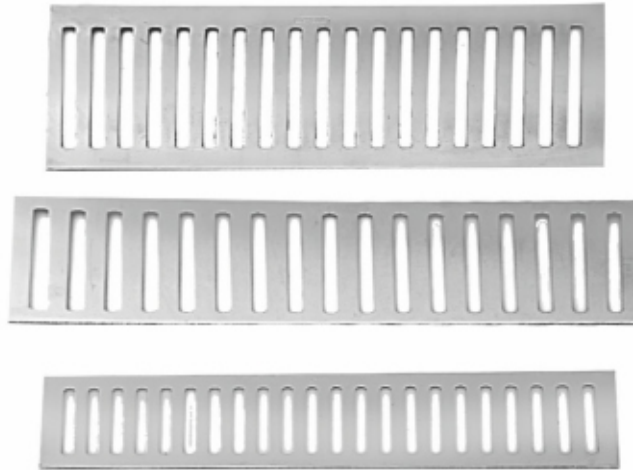

Code	Name	Size	Rate in Rs.(Per Box)
RCD 007	Rail Drainer Width 3"	75x150mm (3-6")	790/-
RCD 008	Rail Drainer Width 3"	75x200mm (3-8")	990/-
RCD 009	Rail Drainer Width 3"	75x250mm (3-10")	1190/-
RCD 010	Rail Drainer Width 3"	75x300mm (3-12")	1390/-
RCD 011	Rail Drainer Width 3"	75x450mm (3-18")	1980/-
RCD 012	Rail Drainer Width 3"	75x600mm (3-24")	2590/-
RCD 013	Rail Drainer Width 4"	100x150mm (4-6")	890/-
RCD 014	Rail Drainer Width 4"	100x200mm (4-8")	1090/-
RCD 015	Rail Drainer Width 4"	100x250mm (4-10")	1290/-
RCD 016	Rail Drainer Width 4"	100x300mm (4-12")	1590/-
RCD 017	Rail Drainer Width 4"	100x450mm (4-18")	2590/-
RCD 018	Rail Drainer Width 4"	100x600mm (4-24")	3590/-
RCD 019	Rail Drainer Width 6"	150x300mm (6-12")	2890/-
RCD 020	Rail Drainer Width 6"	150x450mm (6-18")	4115/-
RCD 021	Rail Drainer Width 6"	150x600mm (6-24")	5460/-

HEALTH FAUCET

HSN Code: 8481.80.90

Price Per Pc. in INR



THE HEALTHY ALTERNATIVE



JET SPRAY

HSN Code: 8424.20.00

AISI 304 (18/8) Stainless Steel

Price Per Pc. in INR



JET SPRAY STRAIGHT

JSS 01

CP Hose1 mtr.- 58Q/-PPc.



JET SPRAY PARINDA

JSP 01

CP Hose1 mtr.- 61Q/-PPc.



JET SPRAY MULTI

JSM 01

CP Hose1 mtr.- 625/-PPc.



JET SPRAY MULTIGOLD

JSMG 01

CP Hose1 mtr.- 72Q/-PPc.

WASTE COUPLING

HSN Code: SS-7324.90.00 / BRASS- 7418.20.10

Price Per Pc. in INR



SS WASTE
 Coupling FT-32MM
SS-WC-32 FT
 Price Rs. 250/- (Per Pc.)



SS WASTE
 Coupling HT-32MM
SS-WC-32 HT
 Price Rs. 250/- (Per Pc.)



BRASS WASTE
 Coupling HT-32MM
B-WC-32 HT
 Price Rs. 385/- (Per Pc.)



BRASS WASTE
 Coupling FT-32MM
B-WC-32 FT
 Price Rs. 385/- (Per Pc.)



BRASS POP UP
 Waste Coupling
B-PU-WC-32 FT
 Price Rs. 830/- (Per Pc.)



BRASS POP UP
 Waste Coupling 6"
B-PU-WC-6"
 Price Rs. 1,190/- (Per Pc.)



SS WASTE
 Coupling 6"
SS-WC-6"
 Price Rs. 360/- (Per Pc.)



SS WASTE
 Coupling 9"
SS-WC-9"
 Price Rs. 510/- (Per Pc.)



BRASS WASTE
 Coupling 6"
B-WC-6"
 Price Rs. 640/- (Per Pc.)



BRASS WASTE
 Coupling 9"
B-WC-9"
 Price Rs. 960/- (Per Pc.)



BRASS DOOMED
 Coupling
D-WC-32
 Price Rs. 560/- (Per Pc.)

BOTTLE TRAP

HSN Code: 8481.80.20

100 % BRASS CHROME PLATED

Price Per Pc. in INR

BOTTLE TRAP GLASSI

BT GL 01

Both Pipe 7"
 Price Rs.1,350/-

BOTTLE TRAP GLASSI

BT GL 02

Pipe 12" & 7"
 Price Rs.1,550/-

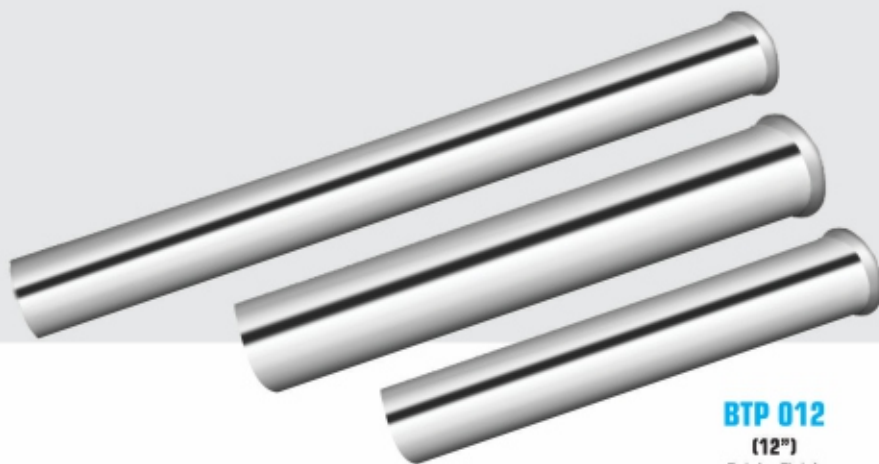

BOTTLE TRAP PIPE

BTP 012
(12")

Bright Finish
 Price Rs. 385/-
 (1 Pc. in box)

BTP 018
(18")

Bright Finish
 Price Rs. 575/-
 (1 Pc. in box)

BTP 024
(24")

Bright Finish
 Price Rs. 775/-
 (1 Pc. in box)

WASTE PIPE

HSN Code: 3917.29.90

Price Per Pc. in INR

Code	Name	Length	Dia	Price
WP- 33	PVC WASTE PIPE- 33"	840mm	30mm	155/-



Code	Name	Length	Dia	Price
W/PB- 33	PVC WASTE PIPE WITH BRASS NUT	840mm	30mm	255/-



Code	Name	Length	Dia	Price
FWP- 33	FLEXIBLE WASTE PIPE	840mm	38mm	55/-



SOAP DISH

HSN Code: 7324.90.00

Price Per Box 10 Pc. in Box INR



PRINCE
PC 001

Bright -Rs. 1,100/-
Matt -Rs. 1,300/-



KOHINOOR
KN 001

Bright -Rs. 1,220/-
Matt -Rs. 1,420/-



PEARL
PL 001

Bright -Rs. 1,100/-
Matt -Rs. 1,300/-



KANCHAN
KC 001

Bright -Rs. 1,150/-
Matt -Rs. 1,300/-

LIQUID SOAP DISPENSER

HSN Code: 7324.90.00

AISI 304 (18/8) Stainless Steel

Price Per Pc. in INR

LIQUID SOAP DISPENSER

LSD 01

Bright -Rs. 1800/-

Matt- Rs. 2000/-



PUMP LIQUID SOAP DISPENSER

LSDP 02

Rs. 250/-

TOILET PAPER HOLDER

HSN Code: 7324.90.00

AISI 304 (18/8) Stainless Steel

Price Per Pc. in INR



TOILET PAPER HOLDER

Regular Elevated

TPRE 03

Bright -Rs. 470/-

Matt- Rs. 560/-



TOILET PAPER HOLDER

Wall mounted with cutter

TPH WMC 04

Bright -Rs. 980/-

Matt- Rs. 1090/-



TOILET PAPER HOLDER

Concealed with cutter

TPH CC 06

Bright -Rs. 1780/-

Matt- Rs. 1980/-



TISSUE HOLDER CONCEALED

Tissue Holder Concealed

SS THC 01

Bright Finish.

Bright: Rs. 980/-

Matt: Rs. 1090/-

FLANGES

HSN Code: 7307.21.00

Price Per Pc. in INR

1



NEW PUNJAB

NP 001

Price (10 Pcs.)
 Bright -Rs. 450/-
 Matt- Rs. 600/-

2



GERMAN

GM 001

Price (10 Pcs.)
 Bright -Rs. 380/-
 Matt- Rs. 580/-

3



BIG FANCY

BF 001

Price (Per100 Pc.)
 Bright -Rs.2490/-
 Matt- Rs. 3090/-

4



SLEEK

SK 001

Price (20 Pcs.)
 Bright -Rs. 640/-
 Matt- Rs. 840/-

5



SMALL FANCY

SF 001

Price (100 Pcs.)
 Bright -Rs. 1980/-
 Matt- Rs. 2580/-

6



DOOM FLANGE

DM 001

Price (10 Pcs.)
 Bright -Rs. 450/-
 Matt- Rs. 600/-

7



SQUARE SMALL FLANGE

SSF 001

Price (10 Pcs.)
 Bright -Rs. 540/-
 Matt- Rs. 740/-

8



SQUARE BIG FLANGE

SBF 002

Price (10 Pcs.)
 Bright -Rs. 740/-
 Matt- Rs. 940/-

RACK BOLTS

HSN Code: 7318.11.10

Price Per Set in INR



RACK BOLT CONCEALED 9"

THICKNESS: 16MM
 HEIGHT: 9 inch
SSRBC 01
 Price Rs. 1050/-



● **RACK BOLT SCREW TYPE 7"**

THICKNESS: 16MM
 HEIGHT: 7 inch
SSRBS 02
 PRICE RS. 900/-

● **RACK BOLT SCREW TYPE 9"**

THICKNESS: 16MM
 HEIGHT: 9 inch
SSRBS 03
 PRICE RS. 1,050/-

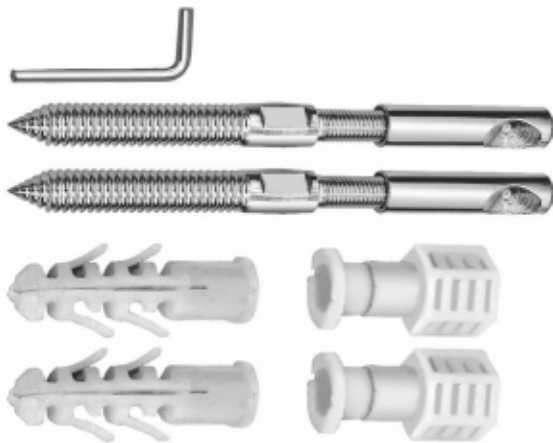

RACK BOLT L- KEY TYPE

THICKNESS: 16MM
 HEIGHT: 9 inch
SSRBL 04
 Price Rs. 1,150/-



RACK BOLT SCREW TYPE FOR WASH BASIN

THICKNESS: 10MM
 HEIGHT: 5 inch
SSRB WB 05
 Price Rs. 275/-



MS RACK BOLT SCREW TYPE FOR WASH BASIN

THICKNESS: 10MM
 HEIGHT: 5 inch
MSRB WB 05
 Price Rs. 75/-

CONNECTION HOSE

HSN Code: 3917.29.90

Price Per Pc. in INR
20 Pcs. Box Packing



AISI 304 (18/8) Stainless Steel

Code	Name	Length	Dia	Price
PVC 12	PVC CONNECTION HOSE	300mm	16mm	180/-
PVC 18	PVC CONNECTION HOSE	450mm	16mm	190/-
PVC 24	PVC CONNECTION HOSE	600mm	16mm	210/-
PVC 30	PVC CONNECTION HOSE	750mm	16mm	230/-
PVC 36	PVC CONNECTION HOSE	900mm	16mm	250/-

FOR HOT & COLD

Code	Name	Length	Dia	Price
SS-CP-12	SS CONNECTION HOSE	300mm	16mm	240/-
SS-CP-18	SS CONNECTION HOSE	450mm	16mm	285/-
SS-CP-24	SS CONNECTION HOSE	600mm	16mm	345/-
SS-CP-30	SS CONNECTION HOSE	750mm	16mm	405/-
SS-CP-36	SS CONNECTION HOSE	900mm	16mm	465/-

FOR HOT & COLD



3 LAYER

PIPE

Code	Name	Length	Dia	Price
GREY- 18	GREY CONNECTION HOSE	450mm	16mm	235/-
GREY- 24	GREY CONNECTION HOSE	600mm	16mm	275/-

FOR HOT & COLD



Code	Name	Length	Dia	Price
PTMT- 18	PTMT CONNECTION HOSE	450mm	16mm	70/-
PTMT- 24	PTMT CONNECTION HOSE	600mm	16mm	80/-

FOR HOT & COLD

EXTENSION NIPPLE

HSN Code: 8481.80.20

100 % BRASS CHROME PLATED

Price Per Pc. in INR



HEX NIPPLE
HXN 01
 Price Rs. 110/-



EXTENSION NIPPLE
EN 25- 1"
 Price Rs. 100/-



EXTENSION NIPPLE
EN 40- 1.5"
 Price Rs. 100/-



EXTENSION NIPPLE
EN 50- 2"
 Price Rs. 120/-



EXTENSION NIPPLE
EN 63- 2.5"
 Price Rs. 145/-



EXTENSION NIPPLE
EN 70- 3"
 Price Rs. 170/-



EXTENSION NIPPLE
EN 100- 4"
 Price Rs. 200/-



EXTENSION NIPPLE
EN 150- 6"
 Price Rs. 280/-

ALLIED

HSN Code: 8481.80.20

100 % BRASS CHROME PLATED

Price Per Pc. in INR



SANJAY CHILLY ANGLE VALVE
SCS-AV-01
 Price Rs. 450/-



SANJAY CHILLY 2 in 1 ANGLE VALVE
SCS-2in1-AV-02
 Price Rs. 1,400/-



SANJAY CHILLY WATER FILTER VALVE
SCS-WFV-03
 Price Rs. 345/-



SANJAY CHILLY NOZZLE BIB COCK
SCS-NBC-04
 Price Rs. 780/-



SANJAY CHILLY 2 in 1 BIB COCK
SCS-2in1-BC-05
 Price Rs. 1,400/-



SANJAY CHILLY URINAL SPREADER
SCS-US-06
 Price Rs. 580/-



SANJAY CHILLY SS CLOTH LINER
SCS-SS CL 07
 Price Rs. 680/-

HSN Code: 8302.50.00

BATH SPOUTS

HSN Code: 8481.80.20

100 % BRASS CHROME PLATED

Price Per Pc. in INR



WALL BATH SPOUT ROUND

WBSR-01

Price Rs. 1,100/-



WALL BATH SPOUT ROUND WITH BUTTON

WBSRB-02

Price Rs. 1,600/-



WALL BATH SPOUT SQUARE

WBSS-03

Price Rs. 1,400/-



WALL BATH SPOUT SQUARE WITH BUTTON

WBSSB-04

Price Rs. 1,900/-



WALL SPOUT ROUND MOUTH OPERATED BIB COCK

WSRMOBC-04

Price Rs. 1,300/-

SHOWER ARM

HSN Code: 8481.80.20

Price Per Pc. in INR
10 Pcs. Box Packing



SHOWER ARM ROUND 9"
SS SA 09
Price Rs. 210/-



SHOWER ARM ROUND 12"
SS SA 12
Price Rs. 280/-



SHOWER ARM ROUND 15"
SS SA 15
Price Rs. 345/-



SHOWER ARM ROUND 18"
SS SA 18
Price Rs. 430/-



SHOWER ARM ROUND 24"
SS SA 24
Price Rs. 555/-



SHOWER ARM SQUARE 9"
SS SAS 09
Price Rs. 455/-



SHOWER ARM SQUARE 12"
SS SAS 12
Price Rs. 525/-



SHOWER ARM SQUARE 15"
SS SAS 15
Price Rs. 575/-



SHOWER ARM SQUARE 18"
SS SAS 18
Price Rs. 605/-



SHOWER ARM SQUARE 24"
SS SAS 24
Price Rs. 765/-



SHOWER ARM SQUARE CEILING 9"
SS SAC 09
Price Rs. 485/-



Swachh Bharat Abhiyan

CLEANLINESS IS NEXT TO GODLINESS

Since our childhood we have been taught the importance of cleanliness and it becomes part of our habits, and as we say habits become our second nature. The habit of cleanliness and hygiene around not only brings health and well-being rather it adds to the wealth and life of an individual. It not only purifies the atmosphere but purifies our mind and thoughts. A clean and tidy place not only attracts one's attention but also soothes and motivates the positivity in mind. Cleanliness adds the beauty to surroundings and ultimately to the serenity to our minds.

Swachh Bharat Abhiyan is a nationwide cleanliness campaign run by the government of India to cover all the backward statutory towns to make them clean. This campaign involves the construction of toilets, bathrooms, promoting sanitation programmes in the rural areas, cleaning streets, roads and changing the infrastructure of the country to lead the country ahead. It is a step towards building India strong physically health wise and ultimately in its thoughts and ideas.

The Swachh Bharat is an awakening that inspires and alleviates our thoughts from individualism to collectivism. It emphasizes on not only keeping our homes or self clean but to care and extend the same practice to our neighborhood, colony, city and nation as a whole. It's a step that promotes brotherhood and neighborhood approach in maintenance of common and public places as our own.

A country becomes nation when it's citizens takes ownership – this is the spirit behind Swachh Bharat Abhiyaan. To become a part and that important drop in the ocean, we are reminded of the fact that charity begins at home. In bringing hygiene and health to your home.

We at Sanjay Chilly are committed to offer and deliver you the world class products and accessories for your sanitary and drainage needs. We not only support rather promote Swachh Bharat Abhiyaan not only in letters but spirit through our deeds.



The testimony to our achievements
is reflected in the long line up of corporate clients we have had
the opportunity to serve...

TULIP GROUP	SHOBHA DEVELOPERS
SWAMI NARAYAN TEMPLE	AMBIENCE
SEW SUKRIDE	ASHIANA HOUSING LIMITED
OPTUS HOTEL	TATA PROJECTS
OP JINDAL GLOBAL UNIVERSITY	HCL TECHNOLOGIES
DLF BUILDINGS	BG SHIRKE CONSTRUCTION (P) LTD
LARSEN AND TOUBRO LIMITED	CONST OF DMRC
LIBERTY	THE LALIT HOTEL
MARUTI UDYOG	APOLLO HOSPITAL
PEPSI CO	COCA COLA
VOLTAS LIMITED	TAJ HOTELS AND RESORTS



the list goes on...



12.3.2015

Appreciation Letter

We, Duet India Hotels (Hyderabad) Pvt. Ltd. sincerely appreciate the efforts & workmanship of Rishabh Sanitary Appliances Pvt. Ltd. in providing the sanitary fittings especially cockroach traps for our hotel project at Hyderabad, Andhra Pradesh.

Quality of the products supplied supported us to set & maintain the standards as per hospitality guidelines.

We wish Rishabh Sanitary Appliances Pvt. Ltd. great success and anticipate procurement of their products for our future projects.



Luxurious Lifestyle

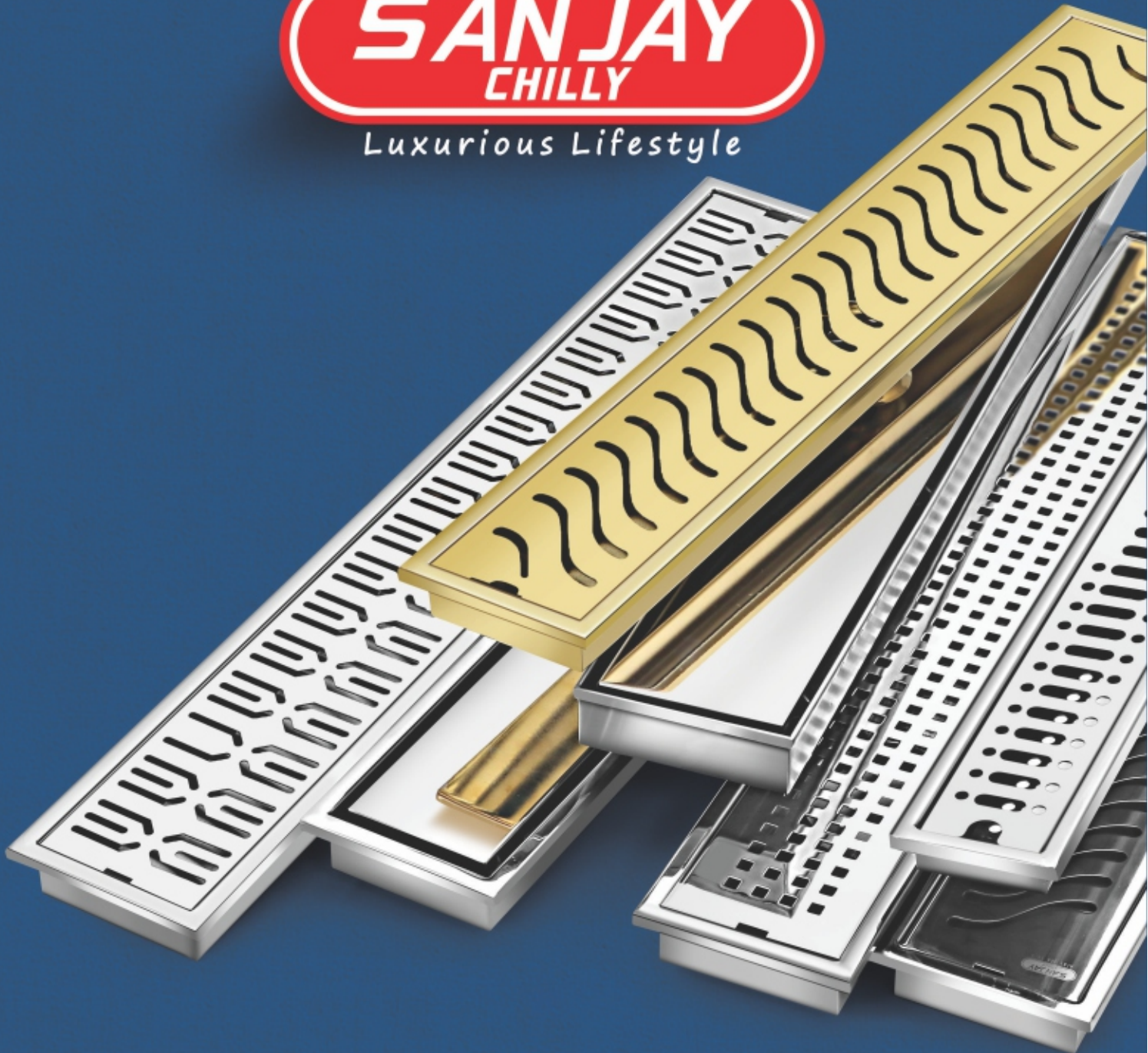

RISHABH SANITARY APPLIANCES PVT. LTD

Email: jain-sanjaychilly@gmail.com

www.sanjaychilly.com